

# PLAN SET 11

## CONSTRUCTION ACTIVITIES

EAST WEST LINK DRAWING REGISTER						
DWG NUMBER	DRAWING TITLE	CURRENT REVISION	DATE AND REVISION			
			1/12/2016	14/12/2016		
	PLAN SET 11 - CONSTRUCTION ACTIVITIES					
AEE-CA-001	CONSTRUCTION ACTIVITIES - EAST WEST LINK - DRAWING INDEX, NOTES AND LEGEND	1	0	1		
AEE-CA-100	CONSTRUCTION ACTIVITIES - EAST WEST LINK - OVERVIEW PLAN	1	0	1		
AEE-CA-101	CONSTRUCTION ACTIVITIES - SH20/NEILSON STREET INTERCHANGE - SHEET 1	0	0			
AEE-CA-102	CONSTRUCTION ACTIVITIES - NEILSON STREET INTERCHANGE - SHEET 2	0	0			
AEE-CA-103	CONSTRUCTION ACTIVITIES - EAST WEST LINK/GALWAY STREET - SHEET 3	0	0			
AEE-CA-104	CONSTRUCTION ACTIVITIES - EMBANKMENT - SHEET 4	0	0			
AEE-CA-105	CONSTRUCTION ACTIVITIES - EMBANKMENT - SHEET 5	0	0			
AEE-CA-106	CONSTRUCTION ACTIVITIES - EMBANKMENT/ANNS CREEK - SHEET 6	0	0			
AEE-CA-107	CONSTRUCTION ACTIVITIES - ANNS CREEK - SHEET 7	1	0	1		
AEE-CA-108	CONSTRUCTION ACTIVITIES - ANNS CREEK/SYLVA PARK ROAD - SHEET 8	1	0	1		
AEE-CA-109	CONSTRUCTION ACTIVITIES - ANNS CREEK/SYLVA PARK RAMPS - SHEET 9	1	0	1		
AEE-CA-110	CONSTRUCTION ACTIVITIES - SH1/SYLVA PARK RAMPS - SHEET 10	0	0			
AEE-CA-111	CONSTRUCTION ACTIVITIES - SH1/PANAMA ROAD - SHEET 11	0	0			
AEE-CA-112	CONSTRUCTION ACTIVITIES - SH1/OTAHUHU CREEK - SHEET 12	0	0			
AEE-CA-113	CONSTRUCTION ACTIVITIES - PRINCES STREET INTERCHANGE - SHEET 13	0	0			
AEE-CA-114	CONSTRUCTION ACTIVITIES - NEILSON STREET INTERCHANGE - LOCAL ROADS - SHEET 14A AND 14B	0	0			
AEE-CA-115	CONSTRUCTION ACTIVITIES - CAPTAIN SPRINGS ROAD/ PORTS LINK - SHEET 15A AND 15B	0	0			
AEE-CA-116	CONSTRUCTION ACTIVITIES - EMBANKMENT - SHEET 16	0	0			
AEE-CA-201	CONSTRUCTION ACTIVITIES - SH1/PANAMA ROAD - BRIDGE STAGING PLAN	0	0			
AEE-CA-202	CONSTRUCTION ACTIVITIES - SH1/OTAHUHU CREEK - BRIDGE STAGING PLAN	0	0			
AEE-CA-203	CONSTRUCTION ACTIVITIES - PRINCES STREET INTERCHANGE - BRIDGE STAGING PLAN	0	0			

**LEGEND: CONSTRUCTION ACTIVITIES**

**PROPOSED FEATURES**

	CONSTRUCTION YARDS		CUT SLOPES
	BUILDING TO BE REMOVED		ROAD ALIGNMENT
	TEMPORARY TRAFFIC DIVERSION		FILL SLOPES
	DREDGING TRENCH		TOE OF OUTER BUND
	BRIDGE STAGING		BRIDGE STRUCTURE
	TEMPORARY TOWERS		CYCLE/ PEDESTRIAN PATH
	TEMPORARY PATH		RETAINING WALL
	DESIGNATION BOUNDARY		AREA OF TEMPORARY OCCUPATION
	OCCUPATION OF COASTAL MARINE AREA (PERMANENT)		OVERLAND FLOW CHANNEL
	TEMPORARY OCCUPATION AREA (WITHIN THE CMA)		

**EXISTING FEATURES**

	PROPERTY BOUNDARY		EXISTING COASTAL MARINE BOUNDARY
	EXISTING SHARED PATH TO REMAIN		

**CONSTRUCTION ACTIVITIES PLANS, REFER DRAWINGS AEE-CA-101 TO AEE-CA-116**

No.	Issued Status	Drawn	Check'd	App'd	Date
1	ISSUED FOR CONSENT - GSR GRADE SEPARATION	JM	NN*	PK*	14/12/2016
0	ISSUED FOR CONSENT	AR	NN*	PK*	01/12/2016

**DISCLAIMER**  
 This drawing is for the purpose of supporting applications under the RMA for resource consents and designations. All information shown is subject to final design. Areas and measurements are subject to survey. Where the designs conflict with conditions the conditions will prevail. This Drawing must not be used for construction.



East West Link

Drawn	A RAM	Drafting Check	J MURAHIDY	Reviewed Design Manager	N NANCEKIVELL	Approved Alliance Manager	P KELLY
Designed	L COLLINS	Design Check	J MURAHIDY				
Scale:	Original Scale (A1)	Reduced Scale (A3)	AS SHOWN	Contract No	PA4014		

Drawing Title	CONSTRUCTION ACTIVITIES EAST WEST LINK DRAWING INDEX, NOTES AND LEGEND			
Drawing Number	AEE-CA-001		Rev No.	1

**FOR CONSENT**



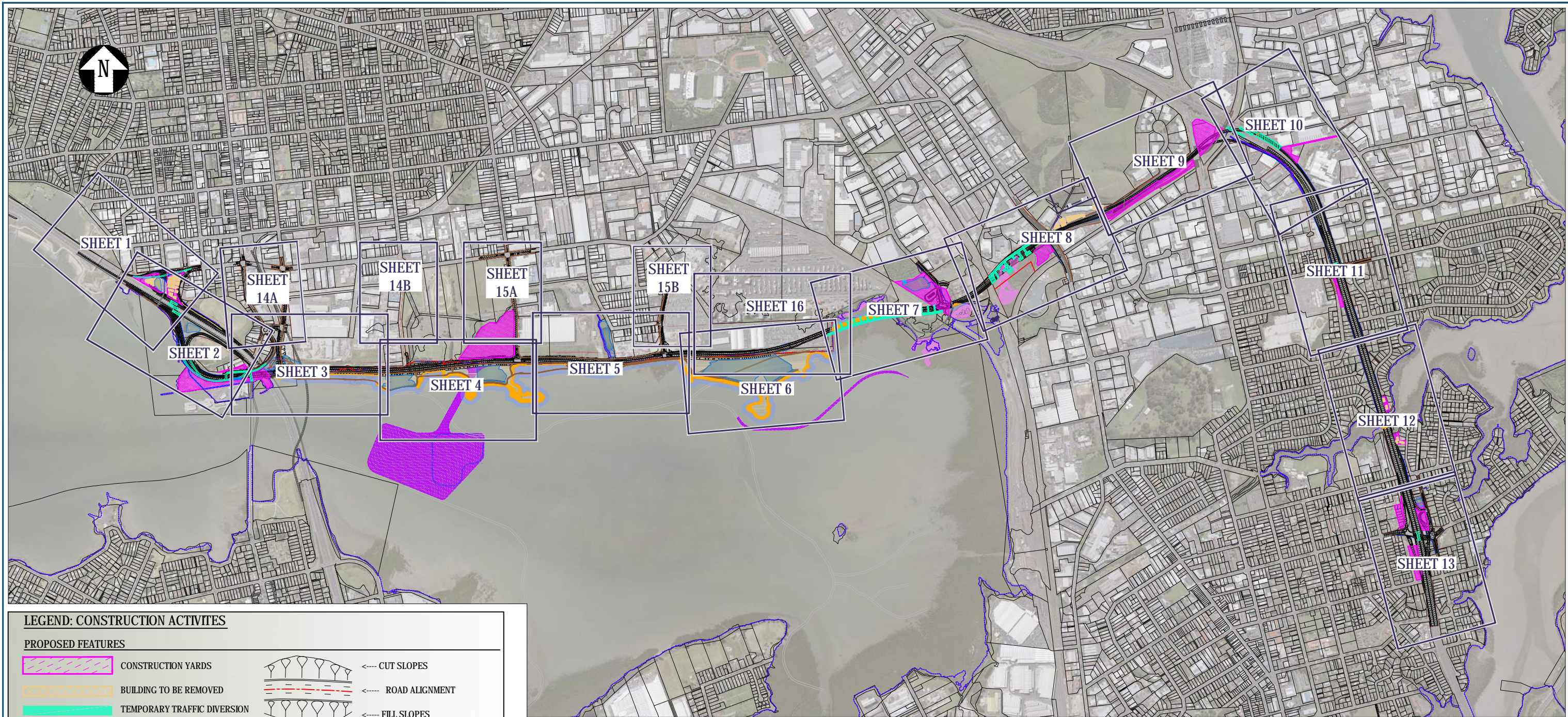

**LEGEND: CONSTRUCTION ACTIVITIES**

**PROPOSED FEATURES**

- |  |   |  |                                  |
|--|---|--|----------------------------------|
|  | CONSTRUCTION YARDS                            |  | CUT SLOPES                       |
|  | BUILDING TO BE REMOVED                        |  | ROAD ALIGNMENT                   |
|  | TEMPORARY TRAFFIC DIVERSION                   |  | FILL SLOPES                      |
|  | DREDGING TRENCH                               |  | TOE OF OUTER BUND                |
|  | BRIDGE STAGING                                |  | BRIDGE STRUCTURE                 |
|  | TEMPORARY TOWERS                              |  | CYCLE/ PEDESTRIAN PATH           |
|  | TEMPORARY PATH                                |  | RETAINING WALL                   |
|  | DESIGNATION BOUNDARY                          |  | AREA OF TEMPORARY OCCUPATION     |
|  | OCCUPATION OF COASTAL MARINE AREA (PERMANENT) |  | OVERLAND FLOW CHANNEL            |
|  | TEMPORARY OCCUPATION AREA (WITHIN THE CMA)    |  | EXISTING COASTAL MARINE BOUNDARY |
|  | PROPERTY BOUNDARY                             |  |                                  |
|  | EXISTING SHARED PATH TO REMAIN                |  |                                  |

CONSTRUCTION ACTIVITIES PLANS, REFER DRAWINGS AEE-CA-101 TO AEE-CA-116

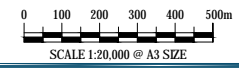

**FOR CONSENT**

No.	Issued Status	Drawn	Check'd	App'd	Date
1	ISSUED FOR CONSENT - GSR GRADE SEPARATION	AR	NN*	PK*	14/12/2016
0	ISSUED FOR CONSENT	AR	NN*	PK*	01/12/2016

**DISCLAIMER**  
 This drawing is prepared under the Resource Management Act 1991 for resource consents and designations. Areas and measurements are subject to survey. Where the designs conflict with conditions the conditions will prevail. This Drawing must not be used for construction.



Drawn A RAM	Drafting Check J MURAHIDY	Reviewed Design Manager N NANCEKIVELL	Approved Alliance Manager P KELLY
Designed L COLLINS	Design Check J MURAHIDY	1/12/16	1/12/16
Scale: Original Scale (A1)	Reduced Scale (A3)	AS SHOWN	Contract No <b>PA4014</b>

Drawing Title <b>CONSTRUCTION ACTIVITIES EAST WEST LINK OVERVIEW PLAN</b>	Drawing Number <b>AEE-CA-100</b>	Rev No. <b>1</b>
--	-------------------------------------	---------------------





**INDICATIVE CONSTRUCTION STAGING FOR NELSON STREET OVERBRIDGE:**

- STAGE 1, 2 AND 3:**  
 1.1 REALIGN SH20 TO PROVIDE WORK AREA FOR BRIDGE PIER CONSTRUCTION.  
 1.2 CONSTRUCT PILES, PILE CAP, COLUMNS AND PIER CAP.  
**STAGE 4:**  
 4.1 CONSTRUCT REMAINING PIERS AND ABUTMENTS.  
**STAGE 5:**  
 5.1 ERECT BRIDGE BEAMS WITH NIGHT CLOSURE.  
**STAGE 6:**  
 6.1 COMPLETE SUPERSTRUCTURE

**NOTE:**  
 PIER LOCATIONS ARE INDICATIVE AND WILL BE FINALISED AT DETAILED DESIGN.

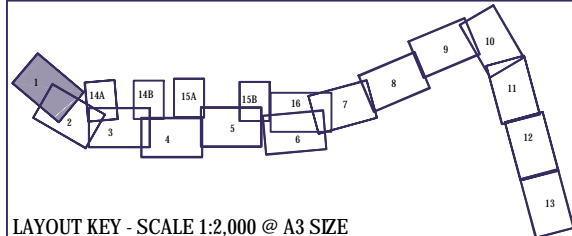
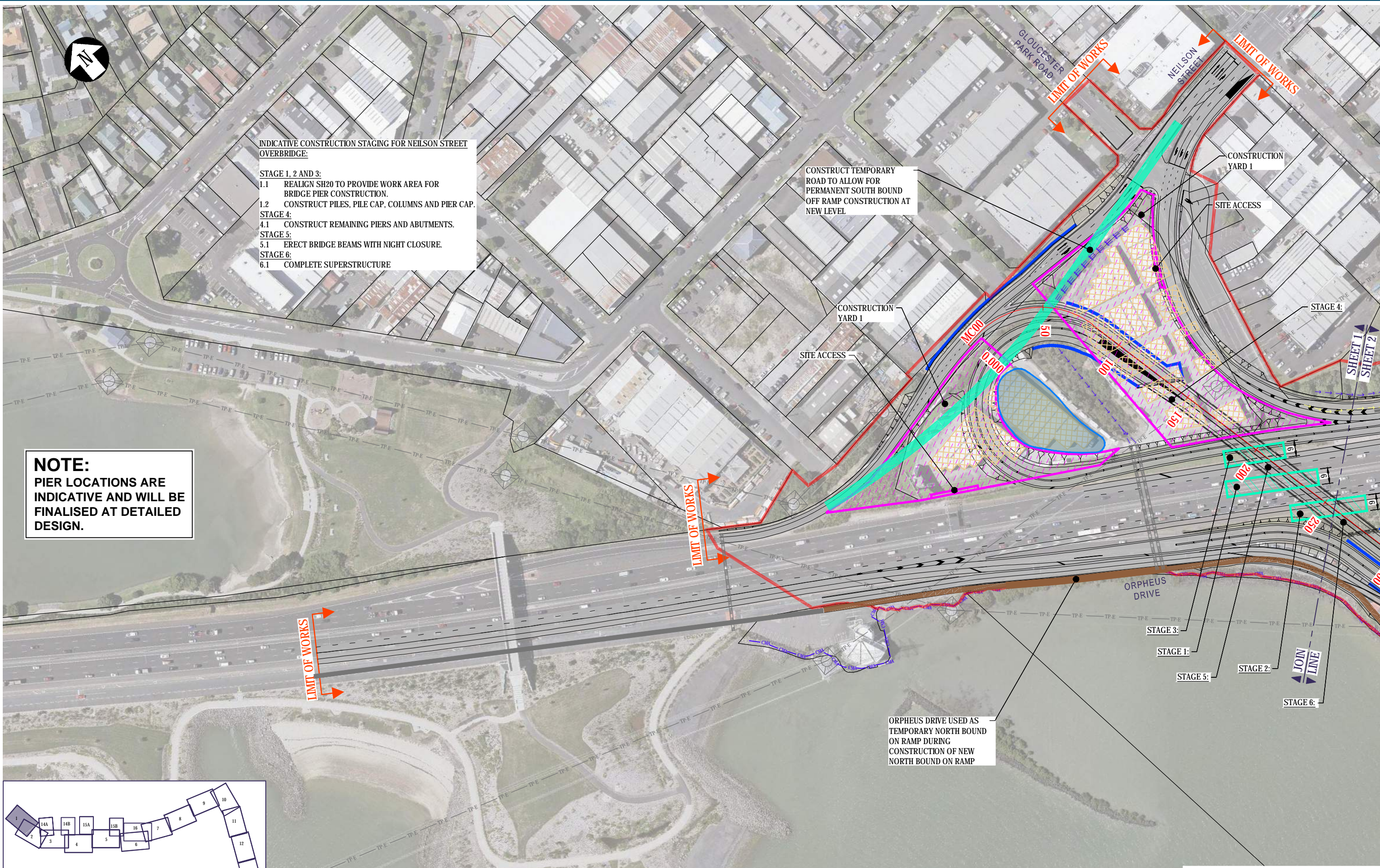

LAYOUT KEY - SCALE 1:2,000 @ A3 SIZE



**FOR CONSENT**

0	ISSUED FOR CONSENT	AR	NN*	PK*	01/12/2016
No.	Issued Status	Drawn	Check'd	App'd	Date

**DISCLAIMER**  
 This drawing is for the purpose of supporting applications under the RMA for resource consents and designations. All information shown is subject to final design. Areas and measurements are subject to survey. Where the designs conflict with conditions the conditions will prevail. This Drawing must not be used for construction

Drawn	A RAM	Drafting Check	J MURAHIDY	Reviewed	N NANCEKIVELL	Approved	P KELLY
Designed	L COLLINS	Design Check	J MURAHIDY	Design Manager	1/12/16	Alliance Manager	1/12/16
Scale:	Original Scale (A1)	Reduced Scale (A3)	AS SHOWN	Contract No	PA4014		

Drawing Title:	CONSTRUCTION ACTIVITIES SH20/ NELSON STREET INTERCHANGE SHEET 1		
Drawing Number:	AEE-CA-101	Rev No.:	0



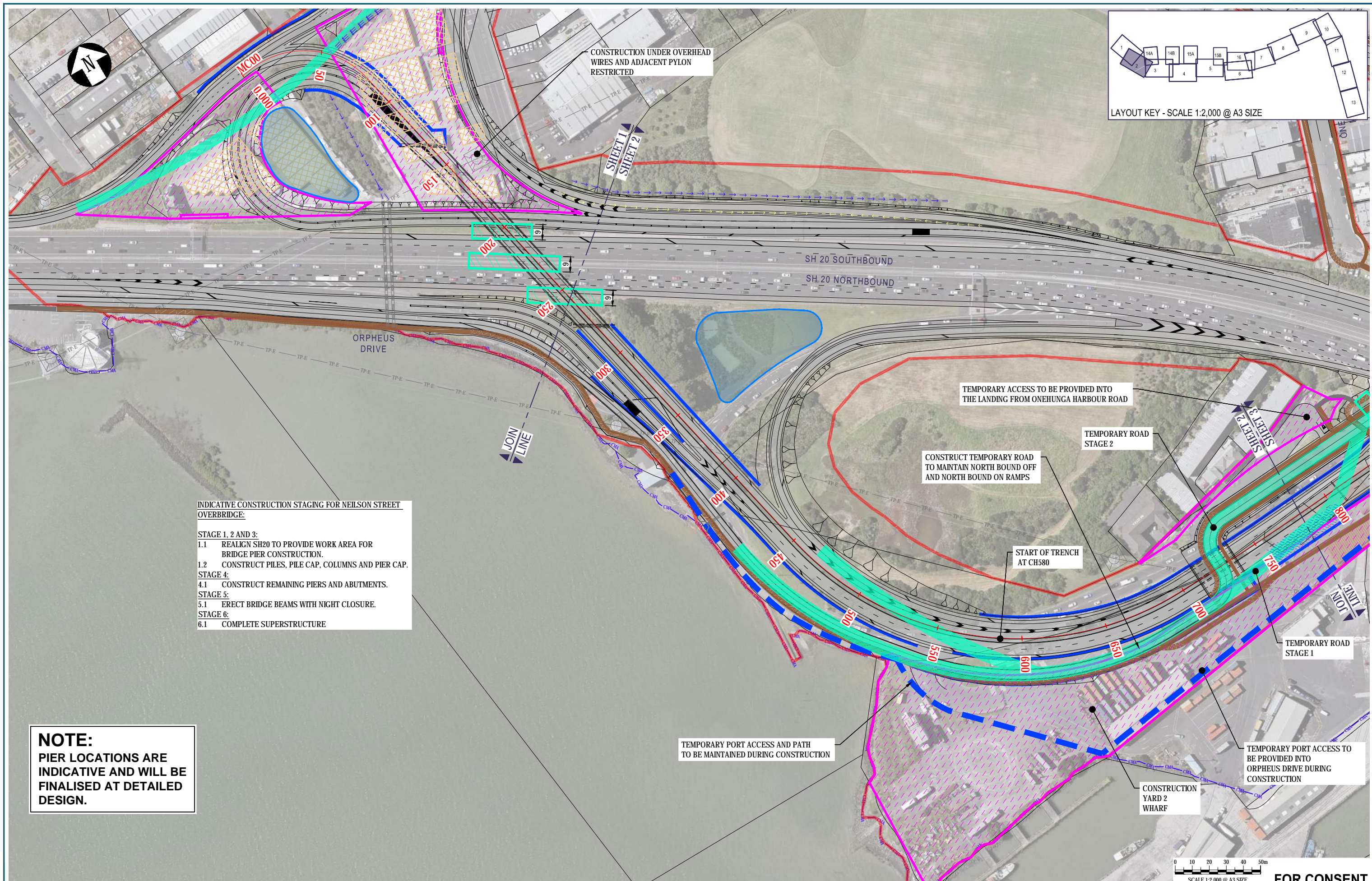

**INDICATIVE CONSTRUCTION STAGING FOR NELSON STREET OVERBRIDGE:**

**STAGE 1, 2 AND 3:**

- 1.1 REALIGN SH20 TO PROVIDE WORK AREA FOR BRIDGE PIER CONSTRUCTION.
- 1.2 CONSTRUCT PILES, PILE CAP, COLUMNS AND PIER CAP.

**STAGE 4:**

- 4.1 CONSTRUCT REMAINING PIERS AND ABUTMENTS.

**STAGE 5:**

- 5.1 ERECT BRIDGE BEAMS WITH NIGHT CLOSURE.

**STAGE 6:**

- 6.1 COMPLETE SUPERSTRUCTURE

**NOTE:**  
PIER LOCATIONS ARE INDICATIVE AND WILL BE FINALISED AT DETAILED DESIGN.

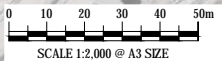

**FOR CONSENT**

No.	Issued Status	Drawn	Check'd	App'd	Date
0	ISSUED FOR CONSENT	AR	NN*	PK*	01/12/2016

**DISCLAIMER**  
 Hāwhiri te itahi māori i te tūāwhiri o te ao... under the RMA for resource consents and designations. 5' ōzha ūhēgēckb ēgē VVMe 7hU'Xēgē b' Areas and measurements are subject to survey. Where the designs conflict with conditions the conditions prevail. This Drawing must not be used for construction

**East West Link**

Drawn A RAM	Drafting Check J MURAHIDY	Reviewed Design Manager N NANCEKIVELL	Approved Alliance Manager P KELLY
Designed L COLLINS	Design Check J MURAHIDY	1/12/16	1/12/16
Scale: Original Scale (A1)	Reduced Scale (A3)	AS SHOWN	Contract No <b>PA4014</b>

Drawing Title <b>CONSTRUCTION ACTIVITIES NELSON STREET INTERCHANGE SHEET 2</b>	Rev No. 0
Drawing Number <b>AEE-CA-102</b>	





JOIN LINE

SHEET 14A  
SHEET 3

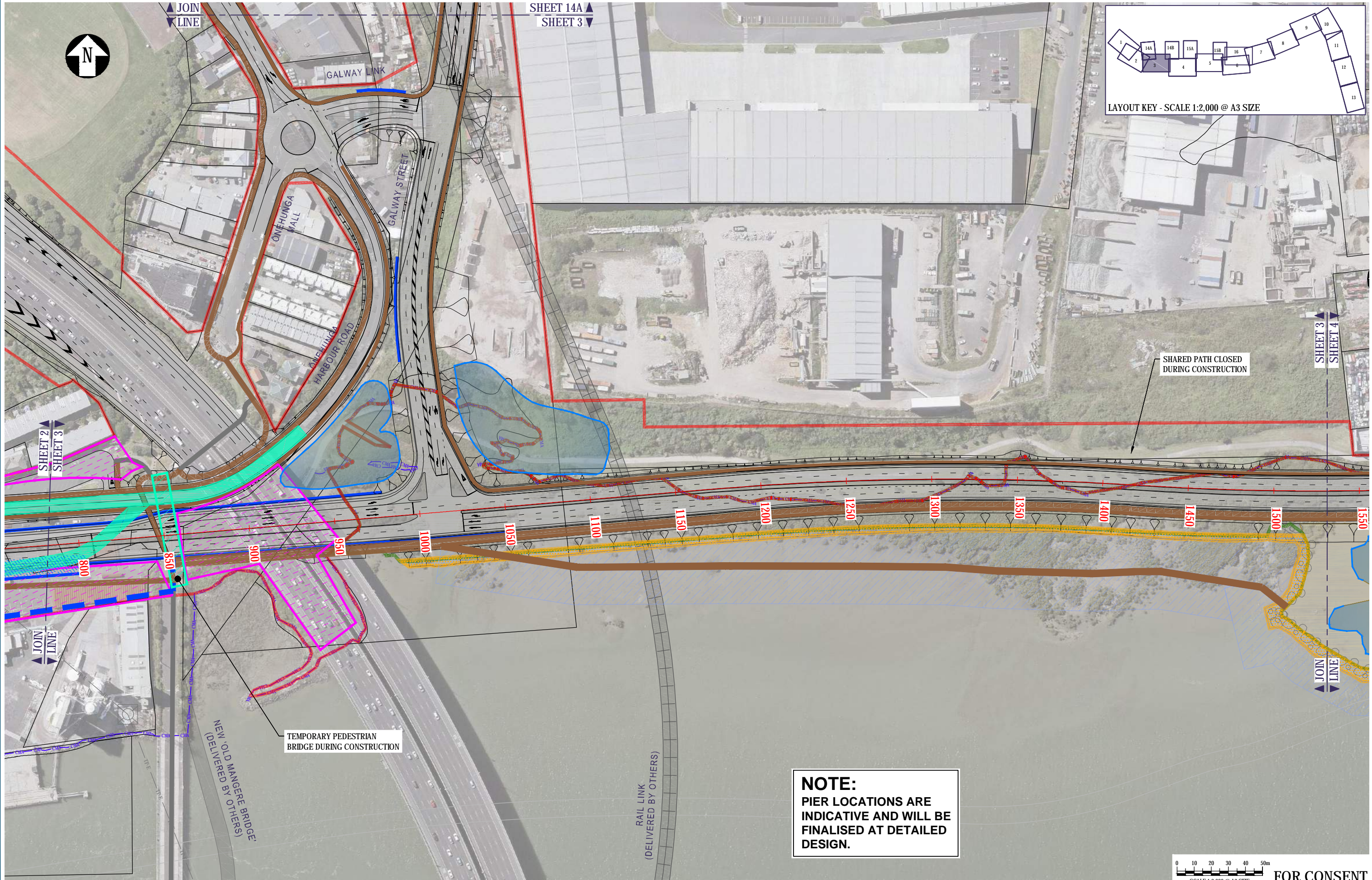
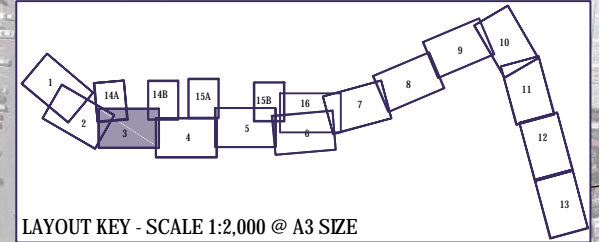

SHARED PATH CLOSED DURING CONSTRUCTION

TEMPORARY PEDESTRIAN BRIDGE DURING CONSTRUCTION

NEW 'OLD MANGERE BRIDGE' (DELIVERED BY OTHERS)

RAIL LINK (DELIVERED BY OTHERS)

**NOTE:**  
PIER LOCATIONS ARE INDICATIVE AND WILL BE FINALISED AT DETAILED DESIGN.

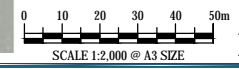

FOR CONSENT

0	ISSUED FOR CONSENT	AR	NN*	PK*	01/12/2016
No.	Issued Status	Drawn	Check'd	App'd	Date

**DISCLAIMER**  
This drawing is for the purpose of supporting applications under the RMA for resource consents and designations. All information shown is subject to final design. Areas and measurements are subject to survey. Where the designs conflict with conditions the conditions will prevail. This Drawing must not be used for construction.

Drawn	A RAM	Drafting Check	J MURAHIDY	Reviewed	N NANCEKIVELL	Approved	P KELLY
Designed	L COLLINS	Design Check	J MURAHIDY	1/12/16			
Scale:	Original Scale (A1)	Reduced Scale (A3)	AS SHOWN	Contract No	PA4014		

Drawing Title:	CONSTRUCTION ACTIVITIES EAST WEST LINK/ GALWAY STREET SHEET 3		
Drawing Number:	AEE-CA-103		
Rev No.	0		



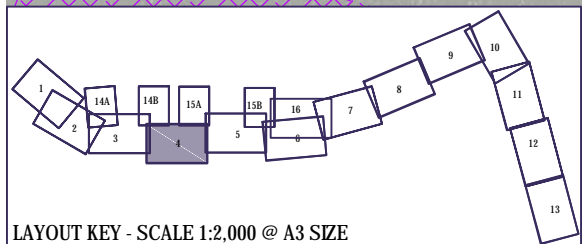
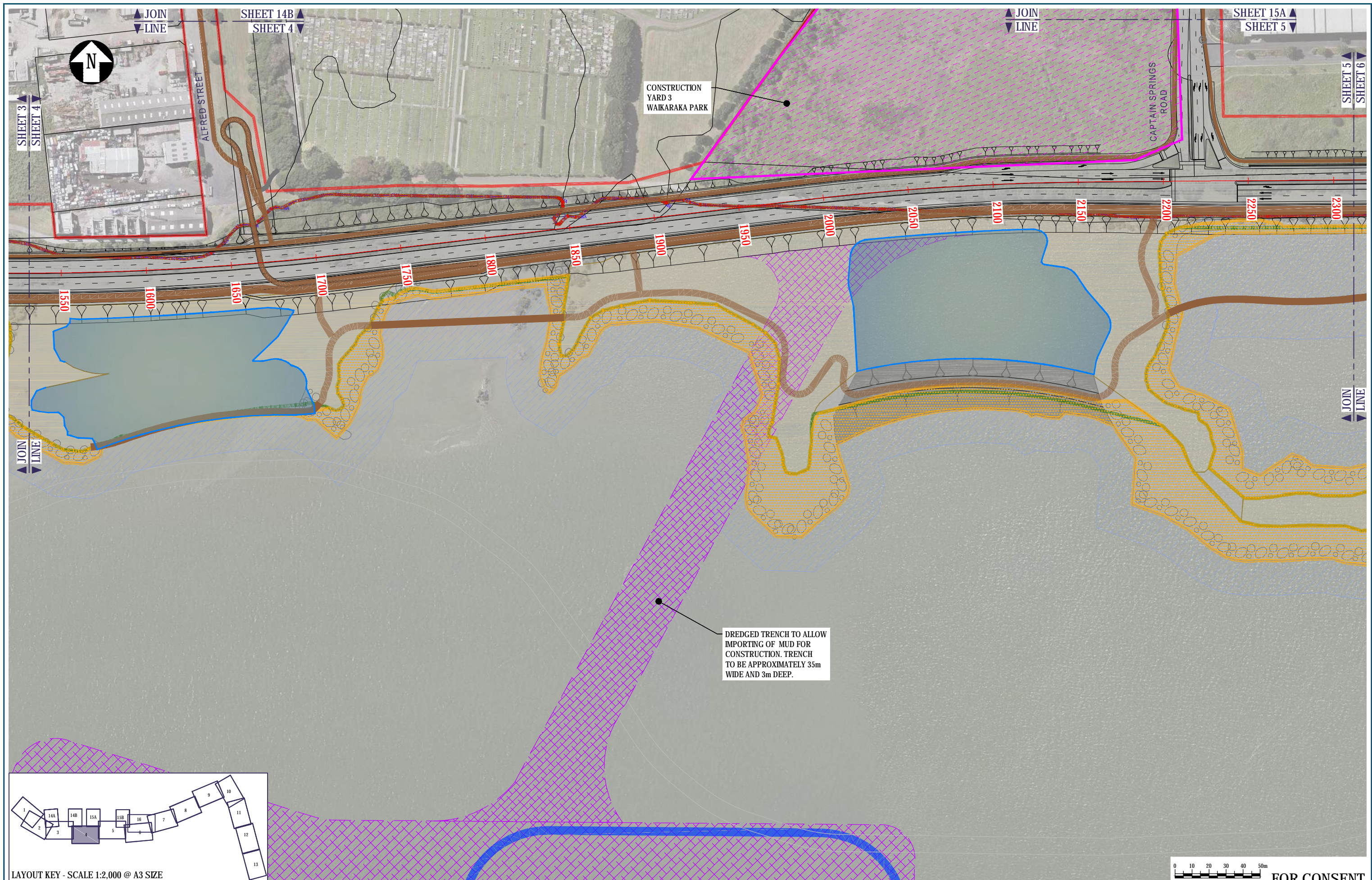

LAYOUT KEY - SCALE 1:2,000 @ A3 SIZE

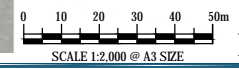

FOR CONSENT

No.	Issued Status	Drawn	Check'd	App'd	Date
0	ISSUED FOR CONSENT	AR	NN*	PK*	01/12/2016

**DISCLAIMER**  
 This drawing is for the purpose of supporting applications under the RMA for resource consents and designations. All information shown is subject to final design. Areas and measurements are subject to survey. Where the designs conflict with conditions the conditions will prevail. This Drawing must not be used for construction

Drawn A RAM	Drafting Check J MURAHIDY	Reviewed Design Manager N NANCEKIVELL	Approved Alliance Manager P KELLY
Designed L COLLINS	Design Check J MURAHIDY	1/12/16	1/12/16
Scale: Original Scale (A1)	Reduced Scale (A3)	AS SHOWN	Contract No PA4014

Drawing Title CONSTRUCTION ACTIVITIES EMBANKMENT SHEET 4	Drawing Number AEE-CA-104	Rev No. 0
---	------------------------------	--------------



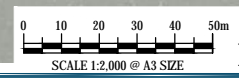
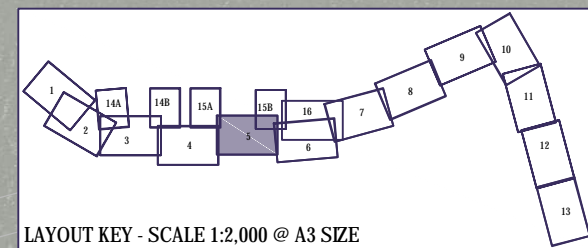

**FOR CONSENT**

No.	Issued Status	Drawn	Check'd	App'd	Date
0	ISSUED FOR CONSENT	AR	NN*	PK*	01/12/2016

**DISCLAIMER**  
 This drawing is for the purpose of supporting applications under the RMA for resource consents and designations. All information shown is subject to final design. Areas and measurements are subject to survey. Where the designs conflict with conditions the conditions will prevail. This Drawing must not be used for construction.

Drawn A RAM	Drafting Check J MURAHIDY	Reviewed Design Manager N NANCEKIVELL	Approved Alliance Manager P KELLY
Designed L COLLINS	Design Check J MURAHIDY	1/12/16	1/12/16
Scale: Original Scale (A1)	Reduced Scale (A3)	AS SHOWN	Contract No <b>PA4014</b>

Drawing Title <b>CONSTRUCTION ACTIVITIES EMBANKMENT SHEET 5</b>	Drawing Number <b>AEE-CA-105</b>	Rev No. <b>0</b>
--	-------------------------------------	---------------------



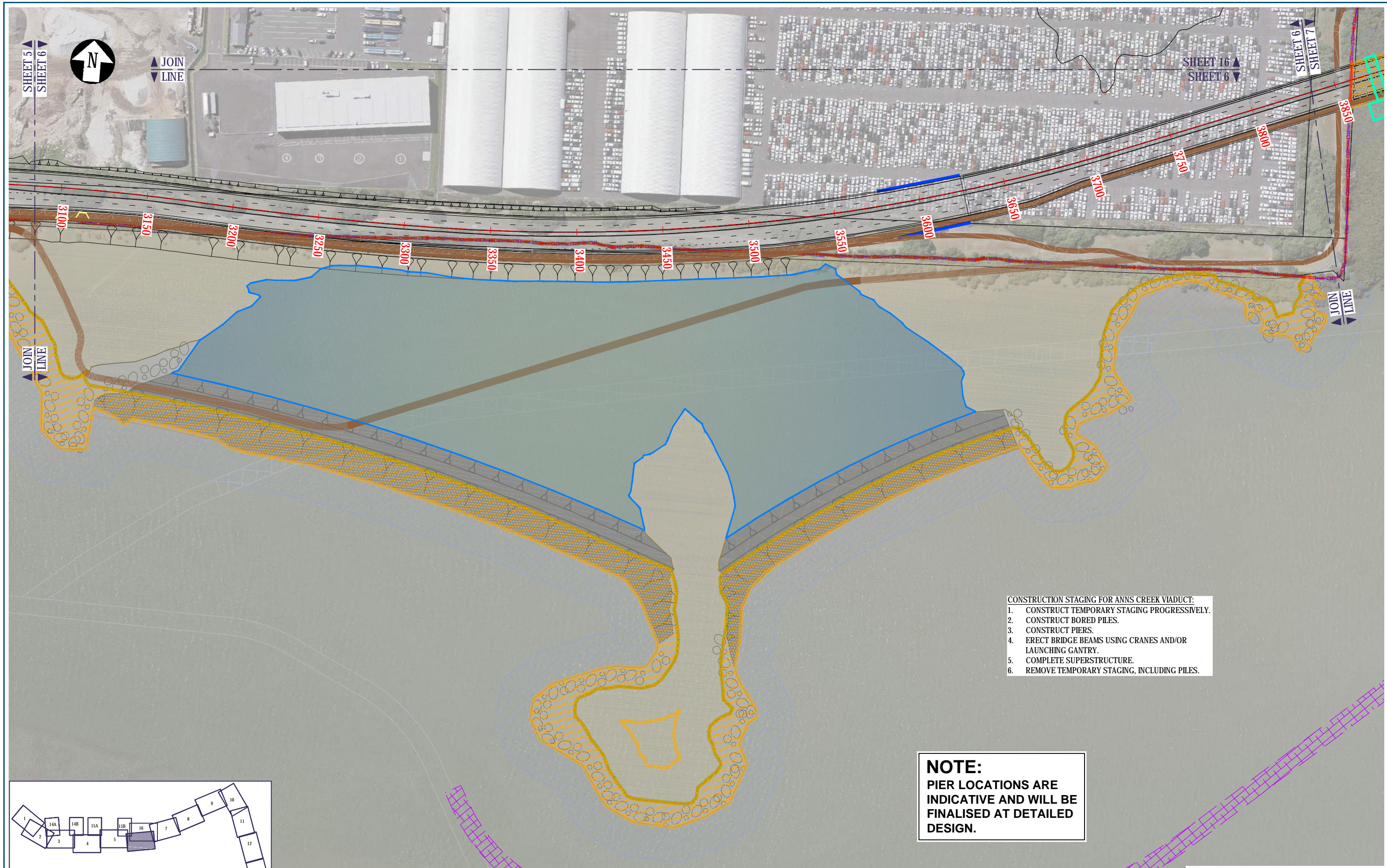

- CONSTRUCTION STAGING FOR ANNS CREEK VIADUCT:**
1. CONSTRUCT TEMPORARY STAGING PROGRESSIVELY.
  2. CONSTRUCT BORED PILES.
  3. CONSTRUCT PIERS.
  4. ERECT BRIDGE BEAMS USING CRANES AND/OR LAUNCHING GANTRY.
  5. COMPLETE SUPERSTRUCTURE.
  6. REMOVE TEMPORARY STAGING, INCLUDING PILES.

**NOTE:**  
PIER LOCATIONS ARE INDICATIVE AND WILL BE FINALISED AT DETAILED DESIGN.

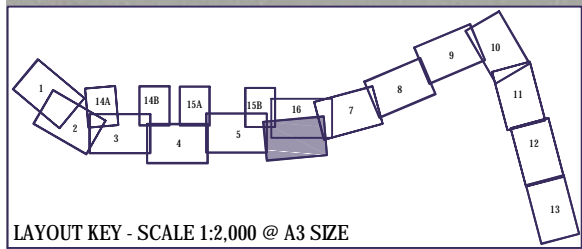

LAYOUT KEY - SCALE 1:2,000 @ A3 SIZE

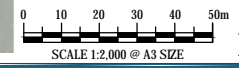

**FOR CONSENT**

No.	Issued Status	Drawn	Check'd	App'd	Date
0	ISSUED FOR CONSENT	AR	NN*	PK*	01/12/2016

**DISCLAIMER**  
This drawing is for the purpose of supporting applications under the RMA for resource consents and designations. All information shown is subject to final design. Areas and measurements are subject to survey. Where the designs conflict with conditions the conditions will prevail. This Drawing must not be used for construction.

Drawn A RAM	Drafting Check J MURAHIDY	Reviewed Design Manager N NANCEKIVELL	Approved Alliance Manager P KELLY
Designed L COLLINS	Design Check J MURAHIDY	1/12/16	1/12/16
Scale: Original Scale (A1)	Reduced Scale (A3)	AS SHOWN	Contract No <b>PA4014</b>

Drawing Title <b>CONSTRUCTION ACTIVITIES EMBANKMENT/ ANNS CREEK SHEET 6</b>	Drawing Number <b>AEE-CA-106</b>	Rev No. <b>0</b>
--	-------------------------------------	---------------------











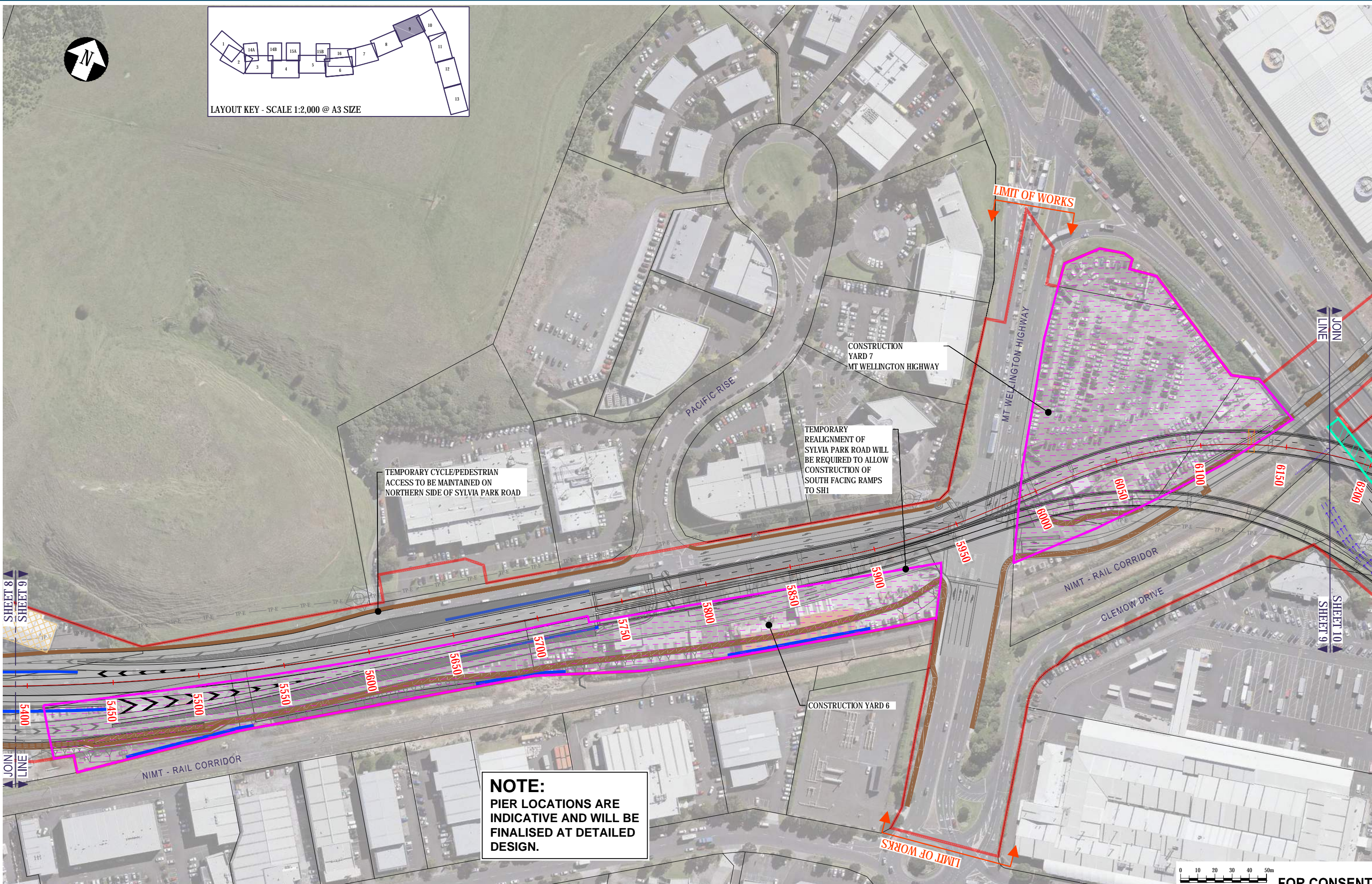
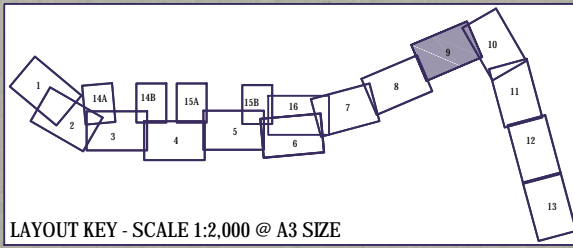

TEMPORARY CYCLE/PEDESTRIAN ACCESS TO BE MAINTAINED ON NORTHERN SIDE OF SYLVIA PARK ROAD

CONSTRUCTION YARD 7  
MT WELLINGTON HIGHWAY

TEMPORARY REALIGNMENT OF SYLVIA PARK ROAD WILL BE REQUIRED TO ALLOW CONSTRUCTION OF SOUTH FACING RAMPS TO SH1

CONSTRUCTION YARD 6

**NOTE:**  
PIER LOCATIONS ARE INDICATIVE AND WILL BE FINALISED AT DETAILED DESIGN.

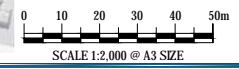

**FOR CONSENT**

No.	Issued Status	Drawn	Check'd	App'd	Date
1	ISSUED FOR CONSENT - GSR GRADE SEPARATION	RT	NN*	PK*	14/12/2016
0	ISSUED FOR CONSENT	AR	NN*	PK*	01/12/2016

**DISCLAIMER**  
Hāwhiri te ika a Māui... under the RMA for resource consents and designations. 5' 12' 3' 4' 5' 6' 7' 8' 9' 10' 11' 12' 13' 14' 15' 16' 17' 18' 19' 20' 21' 22' 23' 24' 25' 26' 27' 28' 29' 30' 31' 32' 33' 34' 35' 36' 37' 38' 39' 40' 41' 42' 43' 44' 45' 46' 47' 48' 49' 50' 51' 52' 53' 54' 55' 56' 57' 58' 59' 60' 61' 62' 63' 64' 65' 66' 67' 68' 69' 70' 71' 72' 73' 74' 75' 76' 77' 78' 79' 80' 81' 82' 83' 84' 85' 86' 87' 88' 89' 90' 91' 92' 93' 94' 95' 96' 97' 98' 99' 100' Areas and measurements are subject to survey. Where the designs conflict with conditions the conditions will prevail. This Drawing must not be used for construction

Drawn	A RAM	Drafting Check	J MURAHIDY	Reviewed	N NANCEKIVELL	Approved	P KELLY
Designed	L COLLINS	Design Check	J MURAHIDY	Design Manager	1/12/16	Alliance Manager	1/12/16
Scale:	Original Scale (A1)	Reduced Scale (A3)	AS SHOWN	Contract No		PA4014	

Drawing Title	CONSTRUCTION ACTIVITIES SH1/ SYLVIA PARK RAMPS SHEET 9		
Drawing Number	AEE-CA-109		
Rev No.	1		



**NOTE:**  
PIER LOCATIONS ARE  
INDICATIVE AND WILL BE  
FINALISED AT DETAILED  
DESIGN.

**STATE HIGHWAY 1 SOUTHBOUND ON RAMP STRUCTURE:**  
**STAGE 1:**  
ESTABLISH AREAS ADJACENT TO A,B AND C (THIS WILL REQUIRE REDUCING LANE WIDTHS). ERECT TEMPORARY PIER SUPPORTS.  
**STAGE 2:**  
DURING NIGHT MOTORWAY CLOSURE, STEEL BEAMS TO BE LIFTED INTO POSITION.  
**STAGE 3:**  
REMOVE TEMPORARY PIER SUPPORTS.

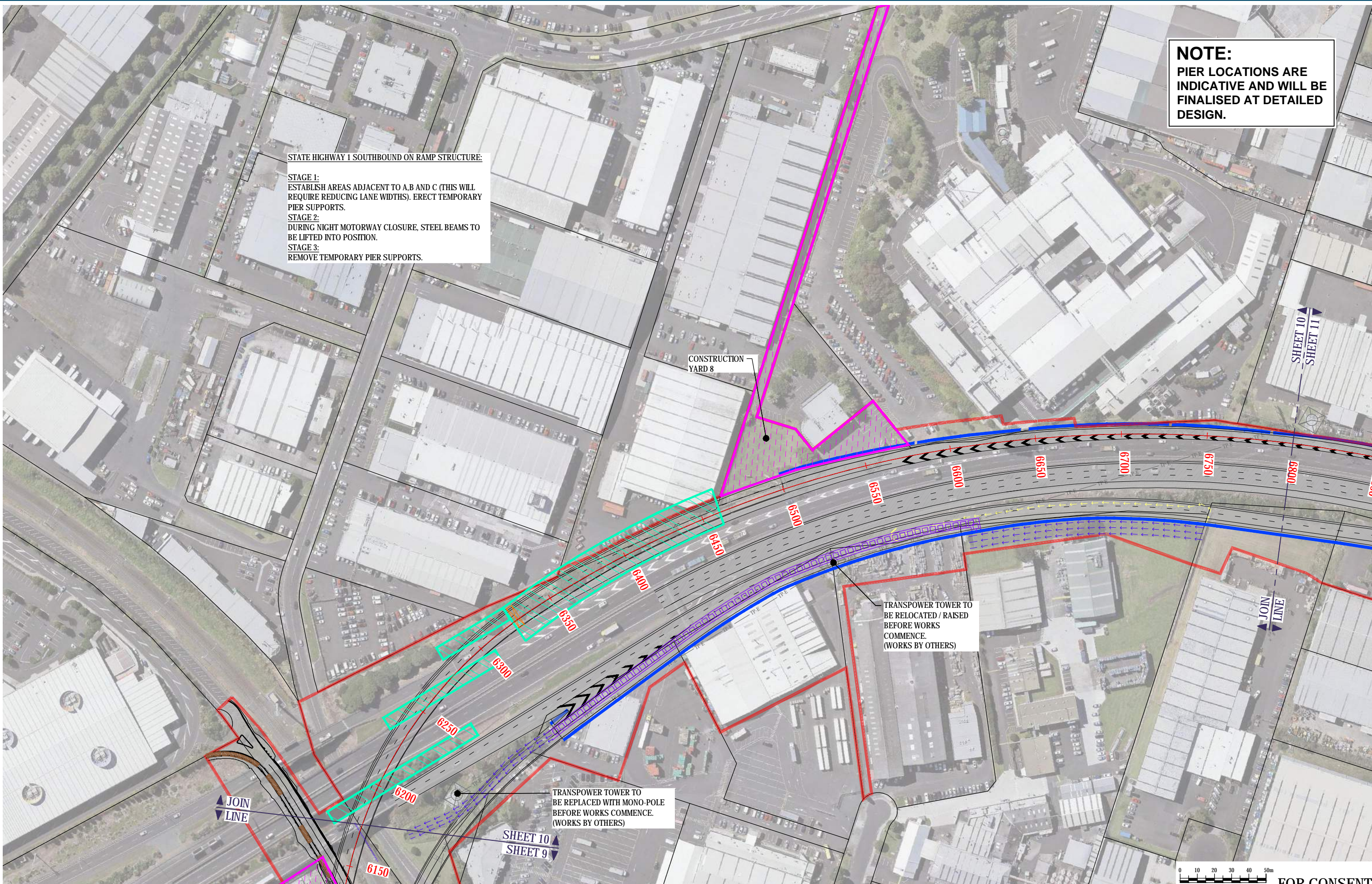

TRANSPOWER TOWER TO BE RELOCATED / RAISED BEFORE WORKS COMMENCE. (WORKS BY OTHERS)

TRANSPOWER TOWER TO BE REPLACED WITH MONO-POLE BEFORE WORKS COMMENCE. (WORKS BY OTHERS)

SCALE 1:2,000 @ A3 SIZE

FOR CONSENT

0	ISSUED FOR CONSENT	AR	NN*	PK*	01/12/2016
No.	Issued Status	Drawn	Check'd	App'd	Date

**DISCLAIMER**  
This drawing is for the purpose of supporting applications under the RMA for resource consents and designations. All information shown is subject to final design. Areas and measurements are subject to survey. Where the designs conflict with conditions the conditions will prevail. This Drawing must not be used for construction

Drawn	A RAM	Drafting Check	J MURAHIDY	Reviewed	N NANCEKIVELL	Approved	P KELLY
Designed	L COLLINS	Design Check	J MURAHIDY	Design Manager	1/12/16	Alliance Manager	1/12/16
Scale:	Original Scale (A1)	Reduced Scale (A3)	AS SHOWN	Contract No	PA4014		

Drawing Title:	CONSTRUCTION ACTIVITIES SH1/ SYLVIA PARK RAMPS SHEET 10		
Drawing Number:	AEE-CA-110	Rev No.	0



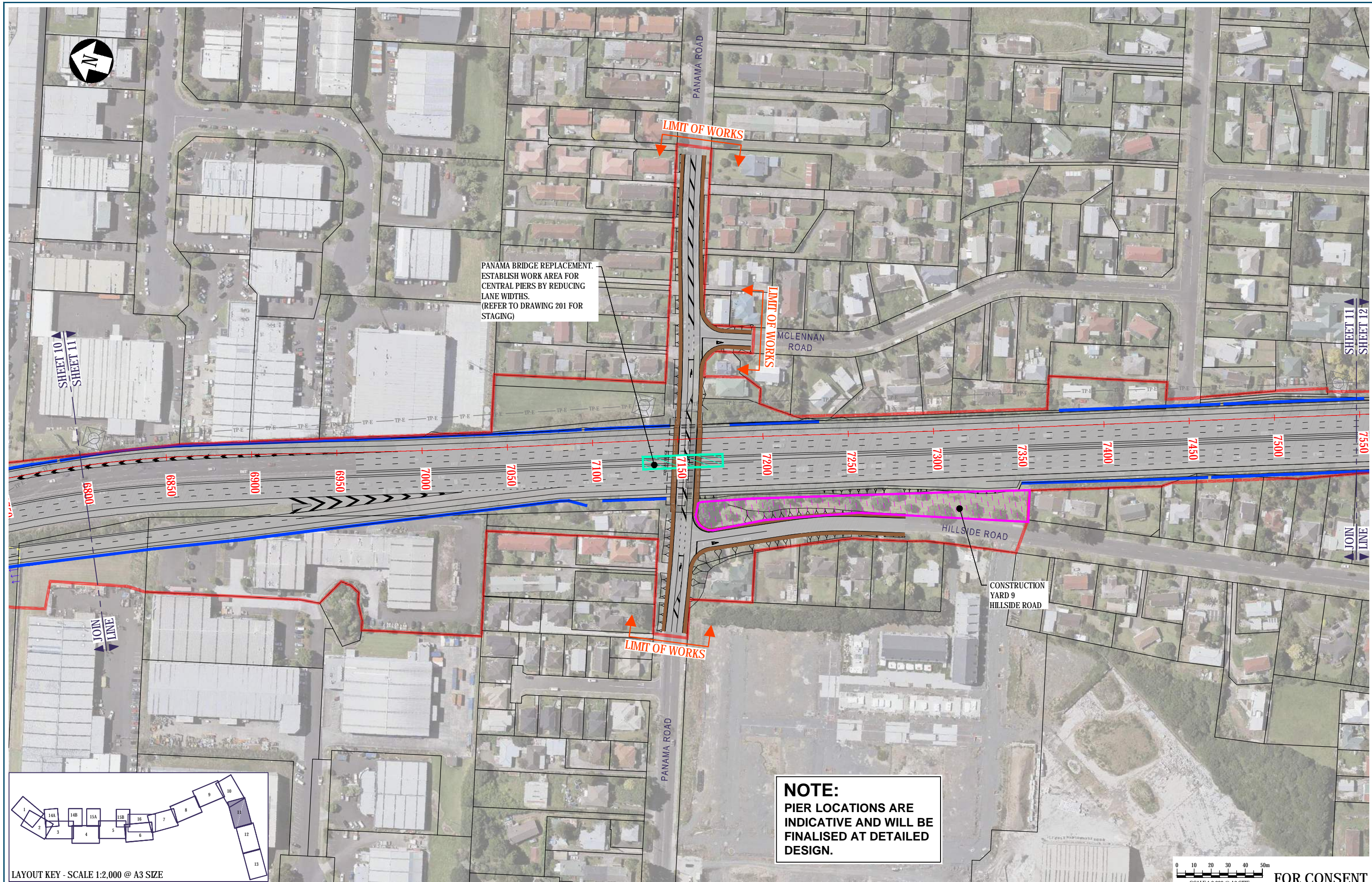

PANAMA BRIDGE REPLACEMENT.  
ESTABLISH WORK AREA FOR  
CENTRAL PIERS BY REDUCING  
LANE WIDTHS.  
(REFER TO DRAWING 201 FOR  
STAGING)

**NOTE:**  
PIER LOCATIONS ARE  
INDICATIVE AND WILL BE  
FINALISED AT DETAILED  
DESIGN.

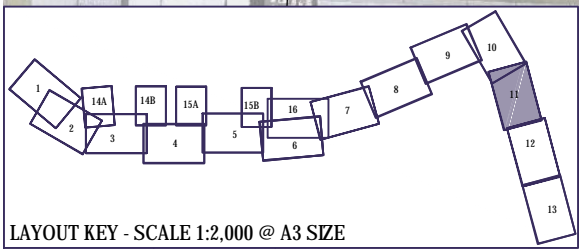

LAYOUT KEY - SCALE 1:2,000 @ A3 SIZE

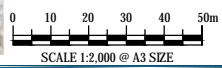

FOR CONSENT

No.	Issued Status	Drawn	Check'd	App'd	Date
0	ISSUED FOR CONSENT	AR	NN*	PK*	01/12/2016

**DISCLAIMER**  
This drawing is for the purpose of supporting applications under the RMA for resource consents and designations. All information shown is subject to final design. Areas and measurements are subject to survey. Where the designs conflict with conditions the conditions will prevail. This Drawing must not be used for construction

Drawn A RAM	Drafting Check J MURAHIDY	Reviewed Design Manager N NANCEKIVELL	Approved Alliance Manager P KELLY
Designed L COLLINS	Design Check J MURAHIDY	1/12/16	1/12/16
Scale: Original Scale (A1)	Reduced Scale (A3)	AS SHOWN	Contract No PA4014

Drawing Title CONSTRUCTION ACTIVITIES SH1/ PANAMA ROAD SHEET 11	Rev No. 0
Drawing Number AEE-CA-111	



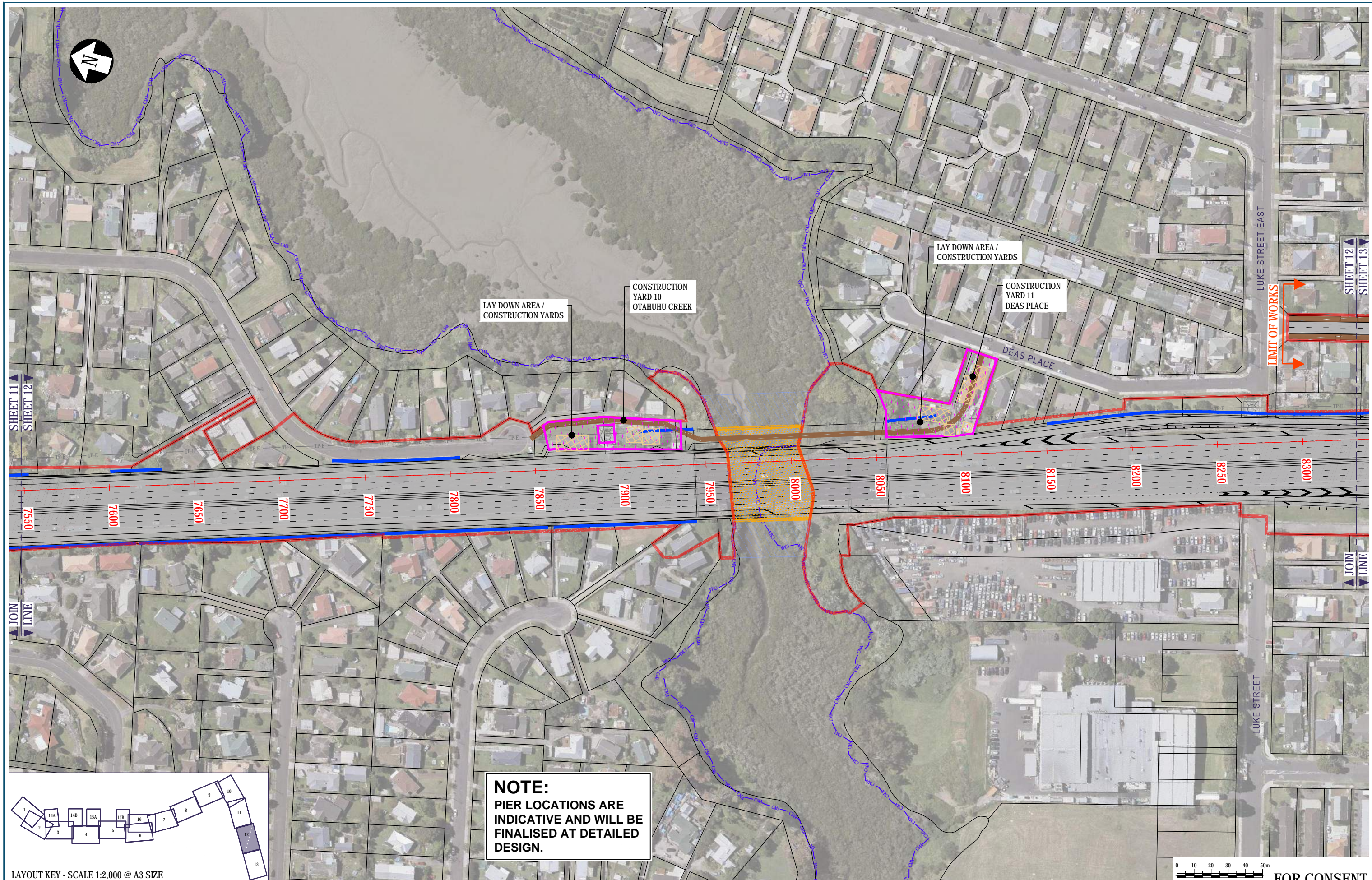

**NOTE:**  
PIER LOCATIONS ARE  
INDICATIVE AND WILL BE  
FINALISED AT DETAILED  
DESIGN.

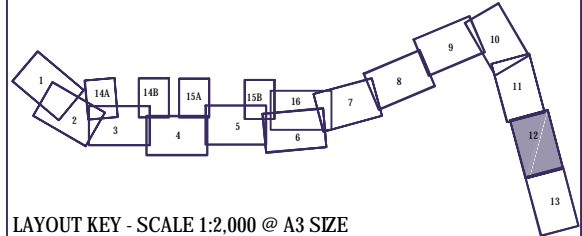

LAYOUT KEY - SCALE 1:2,000 @ A3 SIZE

No.	Issued Status	Drawn	Check'd	App'd	Date
0	ISSUED FOR CONSENT	AR	NN*	PK*	01/12/2016

**DISCLAIMER**  
This drawing is for the purpose of supporting applications under the RMA for resource consents and designations. All information shown is subject to final design. Areas and measurements are subject to survey. Where the designs conflict with conditions the conditions will prevail. This Drawing must not be used for construction

Drawn A RAM	Drafting Check J MURAHIDY	Reviewed Design Manager N NANCEKIVELL	Approved Alliance Manager P KELLY
Designed L COLLINS	Design Check J MURAHIDY	1/12/16	1/12/16
Scale: Original Scale (A1)	Reduced Scale (A3)	AS SHOWN	Contract No PA4014

Drawing Title CONSTRUCTION ACTIVITIES SH1/ OTAHUHU CREEK SHEET 12	Drawing Number AEE-CA-112	Rev No. 0
--	------------------------------	--------------



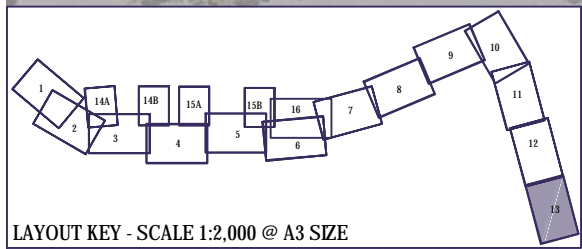
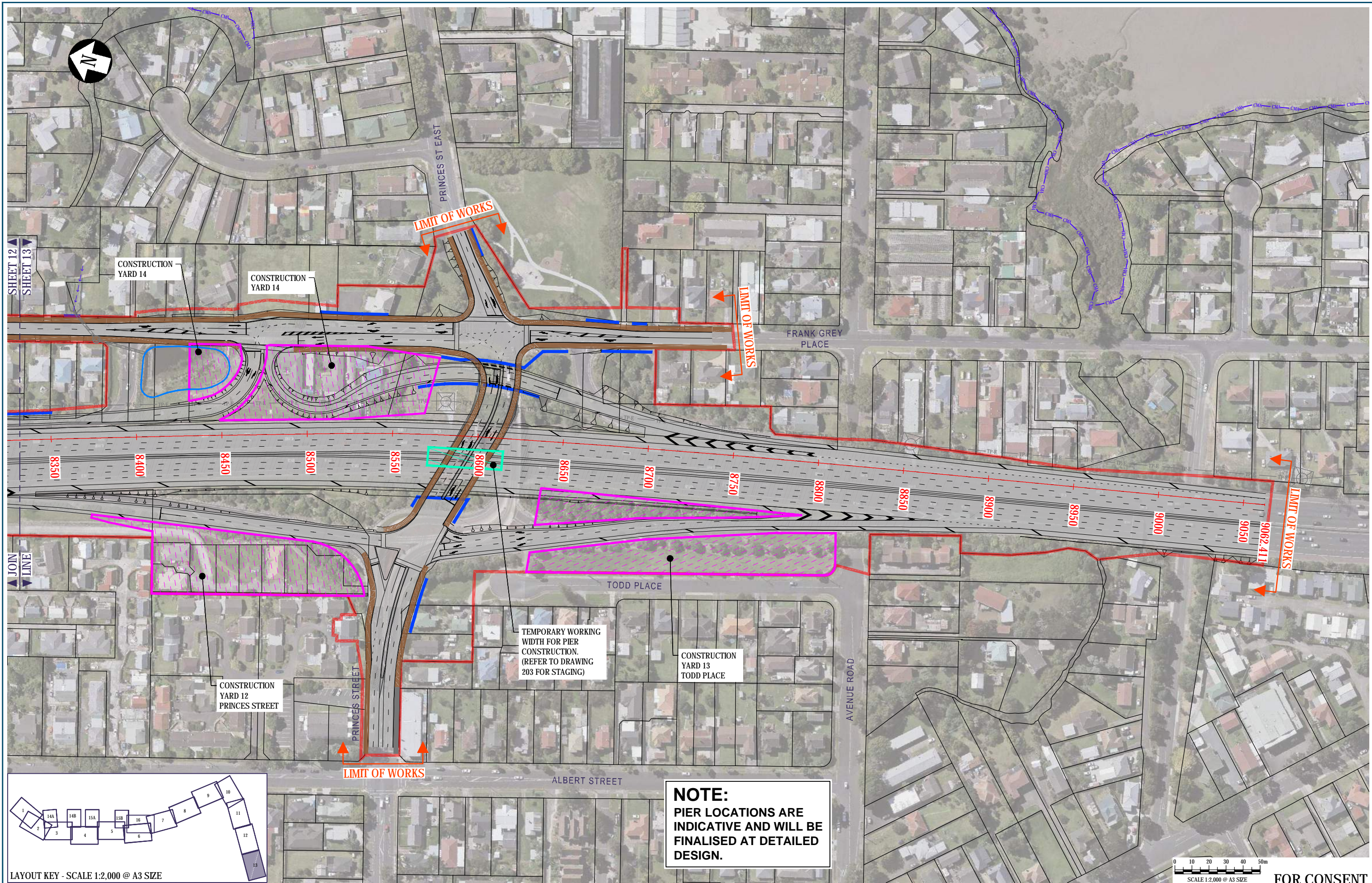

**NOTE:**  
PIER LOCATIONS ARE INDICATIVE AND WILL BE FINALISED AT DETAILED DESIGN.

No.	Issued Status	Drawn	Check'd	App'd	Date
0	ISSUED FOR CONSENT	AR	NN*	PK*	01/12/2016

**DISCLAIMER**  
This drawing is for the purpose of supporting applications under the RMA for resource consents and designations. All information shown is subject to final design. Areas and measurements are subject to survey. Where the designs conflict with conditions the conditions will prevail. This Drawing must not be used for construction.

Drawn A RAM	Drafting Check J MURAHIDY	Reviewed Design Manager N NANCEKIVELL	Approved Alliance Manager P KELLY
Designed L COLLINS	Design Check J MURAHIDY	1/12/16	1/12/16
Scale: Original Scale (A1)	Reduced Scale (A3)	AS SHOWN	Contract No PA4014

Drawing Title <b>CONSTRUCTION ACTIVITIES PRINCES STREET INTERCHANGE SHEET 13</b>	Drawing Number AEE-CA-113	Rev No. 0
---	------------------------------	--------------



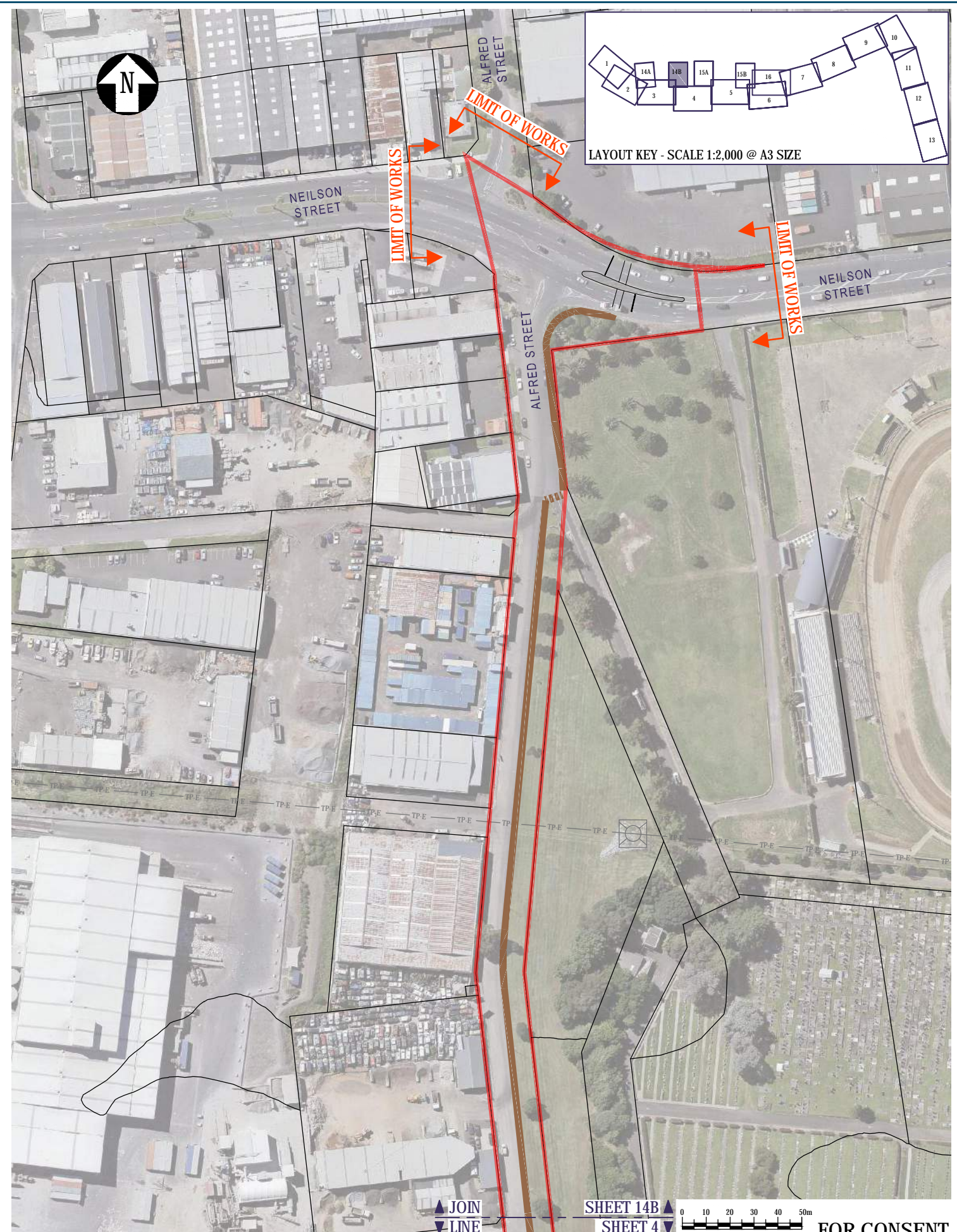
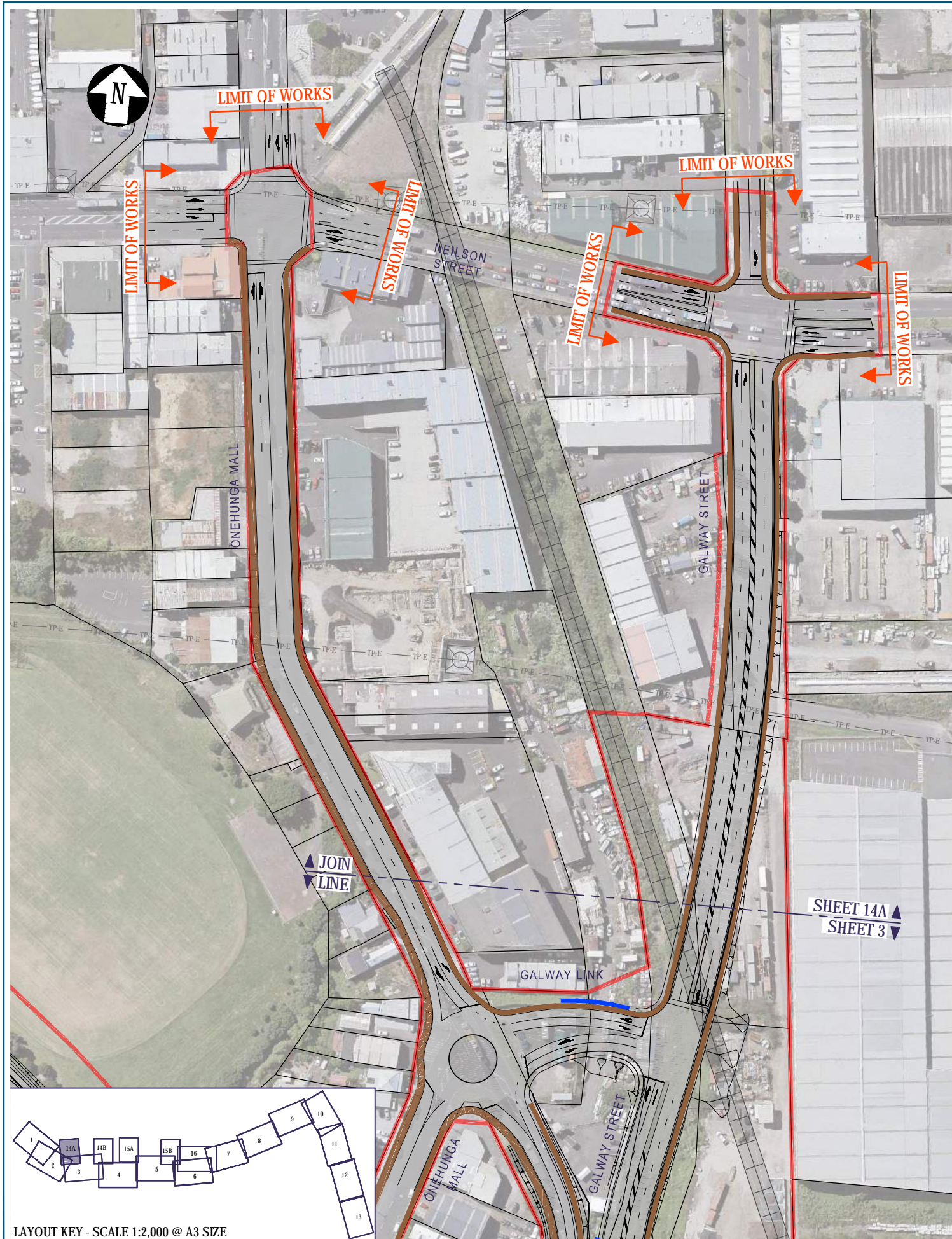

LAYOUT KEY - SCALE 1:2,000 @ A3 SIZE

0	ISSUED FOR CONSENT	AR	NN*	PK*	01/12/2016
No.	Issued Status	Drawn	Check'd	App'd	Date

**DISCLAIMER**  
 This drawing is for the purpose of supporting applications under the RMA for resource consents and designations. All information shown is subject to final design. Areas and measurements are subject to survey. Where the designs conflict with conditions the conditions will prevail. This Drawing must not be used for construction

Drawn	A RAM	Drafting Check	J MURAHIDY	Reviewed Design Manager	N NANCEKIVELL	Approved Alliance Manager	P KELLY
Designed	L COLLINS	Design Check	J MURAHIDY		1/12/16		1/12/16
Scale:	Original Scale (A1)	Reduced Scale (A3)	AS SHOWN	Contract No	PA4014		

Drawing Title:	CONSTRUCTION ACTIVITIES NEILSON STREET INTERCHANGE - LOCAL ROAD SHEET 14A AND 14B		
Drawing Number:	AEE-CA-114		
Rev No.	0		





No.	Issued Status	Drawn	Check'd	App'd	Date
0	ISSUED FOR CONSENT	AR	NN*	PK*	01/12/2016

**DISCLAIMER**  
 This drawing is for the purpose of supporting applications under the RMA for resource consents and designations. All information shown is subject to final design. Areas and measurements are subject to survey. Where the designs conflict with conditions the conditions will prevail. This Drawing must not be used for construction.



**East West Link**

Drawn A RAM	Drafting Check J MURAHIDY	Reviewed Design Manager N NANCEKIVELL	Approved Alliance Manager P KELLY
Designed L COLLINS	Design Check J MURAHIDY	1/12/16	1/12/16
Scale: Original Scale (A1)	Reduced Scale (A3)	AS SHOWN	Contract No PA4014

Drawing Title <b>CONSTRUCTION ACTIVITIES CAPTAIN SPRINGS ROAD/ PORTS LINK SHEET 15A AND 15B</b>	Drawing Number AEE-CA-115	Rev No. 0
--	------------------------------	--------------



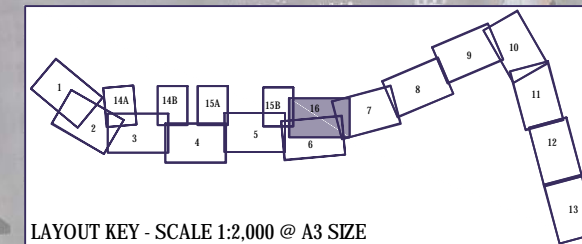

No.	Issued Status	Drawn	Check'd	App'd	Date
0	ISSUED FOR CONSENT	AR	NN*	PK*	01/12/2016

**DISCLAIMER**  
This drawing is for the purpose of supporting applications under the RMA for resource consents and designations. All information shown is subject to final design. Areas and measurements are subject to survey. Where the designs conflict with conditions the conditions will prevail. This Drawing must not be used for construction

Drawn A RAM	Drafting Check J MURAHIDY	Reviewed Design Manager N NANCEKIVELL	Approved Alliance Manager P KELLY
Designed L COLLINS	Design Check J MURAHIDY	1/12/16	1/12/16
Scale: Original Scale (A1)	Reduced Scale (A3)	AS SHOWN	Contract No PA4014

Drawing Title <b>CONSTRUCTION ACTIVITIES EMBANKMENT SHEET 16</b>	Drawing Number AEE-CA-116	Rev No. 0
---	------------------------------	--------------



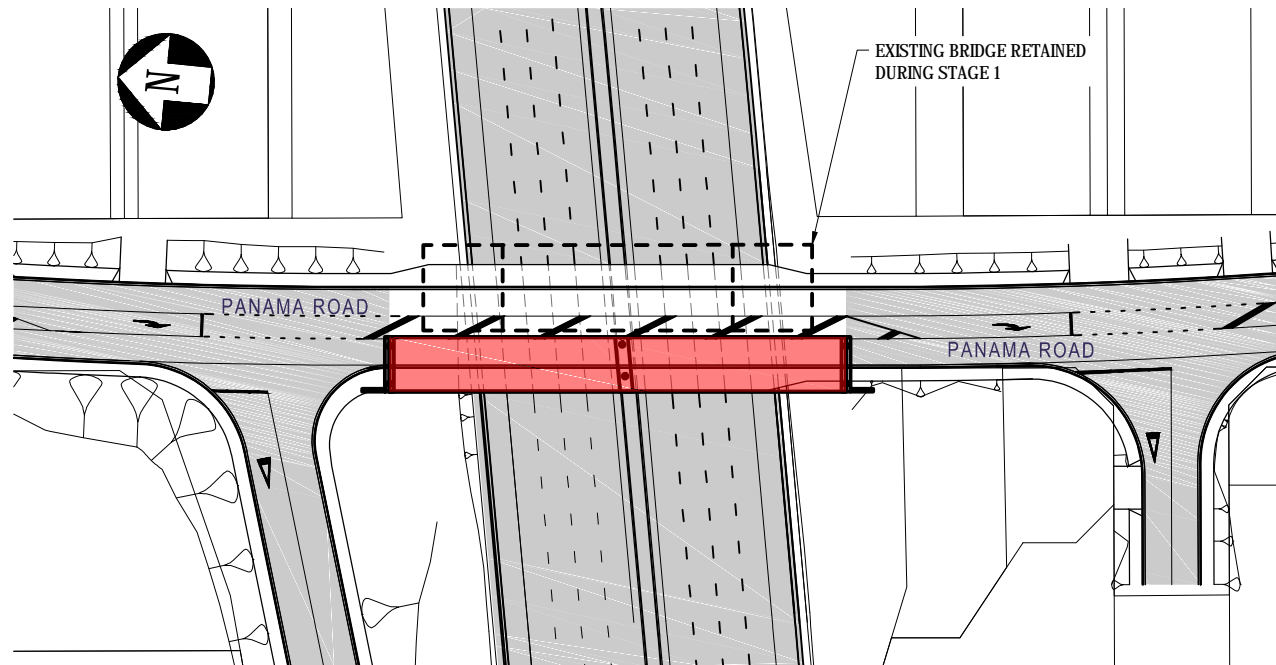

**BRIDGE CONSTRUCTION  
STAGE 1  
(11.25m OF NEW BRIDGE)**  
SCALE 1:2000 @ A3

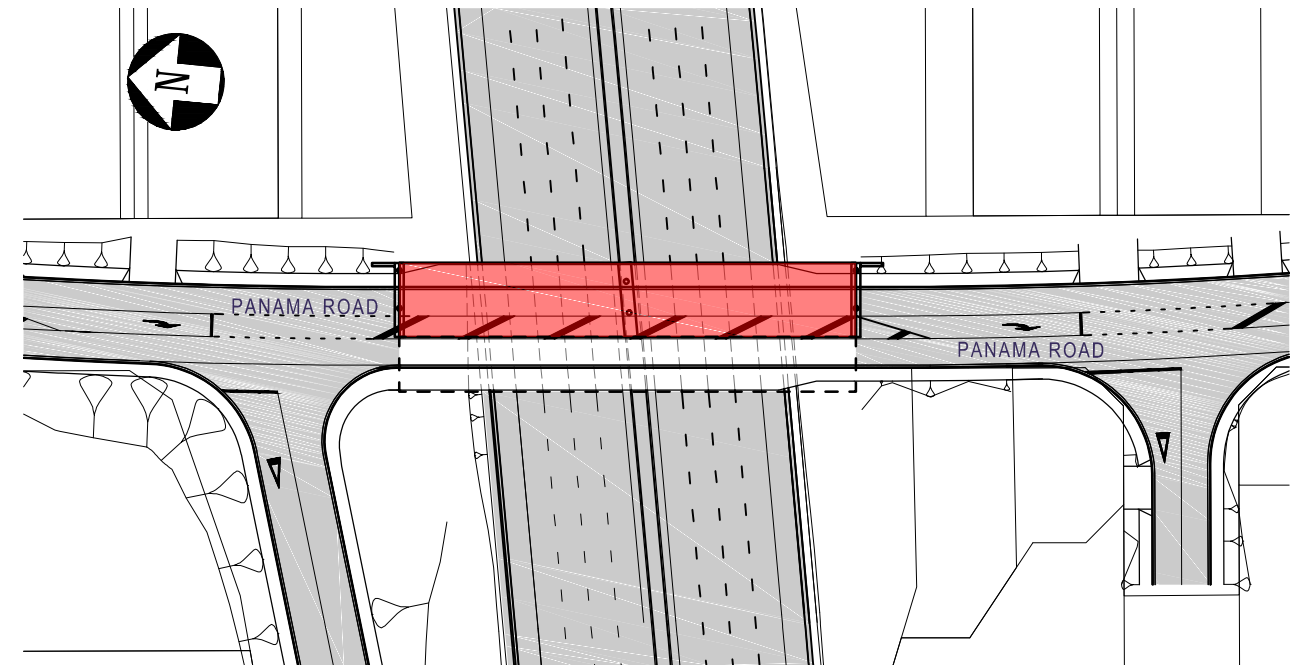

**BRIDGE CONSTRUCTION  
STAGE 2  
DECONSTRUCT EXISTING, CONSTRUCT REMAINING**  
SCALE 1:2000 @ A3

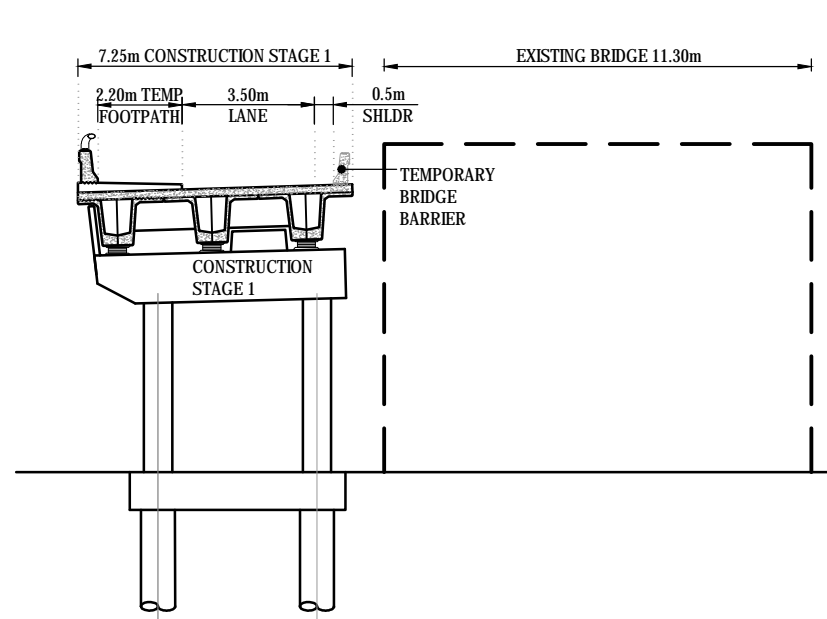

**STAGE 1: CONSTRUCT 7.25m OF NEW BRIDGE**

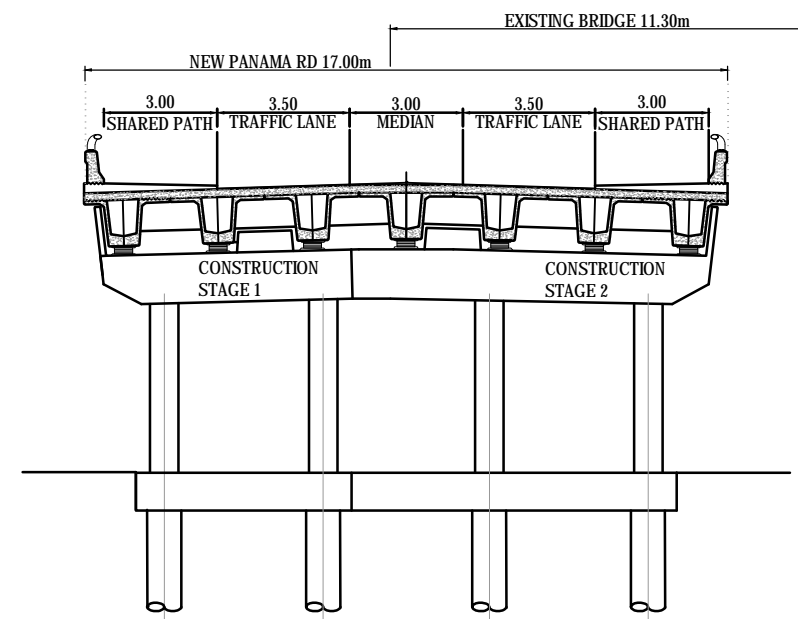

**STAGE 2: DECONSTRUCT EXISTING, CONSTRUCT REMAINING**



**FOR CONSENT**

No.	Issued Status	Drawn	Check'd	App'd	Date
0	ISSUED FOR CONSENT	AR	NN*	PK*	01/12/2016

**DISCLAIMER**  
This drawing is prepared under the Resource Management Act 1991 (RMA) for resource consents and designations. It is not to be used for any other purpose. Areas and measurements are subject to survey. Where the designs conflict with conditions the conditions will prevail. This Drawing must not be used for construction.



**East West Link**

Drawn A RAM	Drafting Check J MURAHIDY	Reviewed Design Manager N NANCEKIVELL	Approved Alliance Manager P KELLY
Designed L COLLINS	Design Check J MURAHIDY	1/12/16	1/12/16
Scale: Original Scale (A1)	Reduced Scale (A3)	AS SHOWN	Contract No <b>PA4014</b>

Drawing Title <b>CONSTRUCTION ACTIVITIES PLAN EAST WEST LINK - SH1/ PANAMA ROAD BRIDGE STAGING PLANS</b>	Rev No. 0
Drawing Number <b>AEE-CA-201</b>	



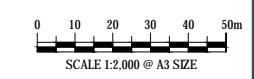
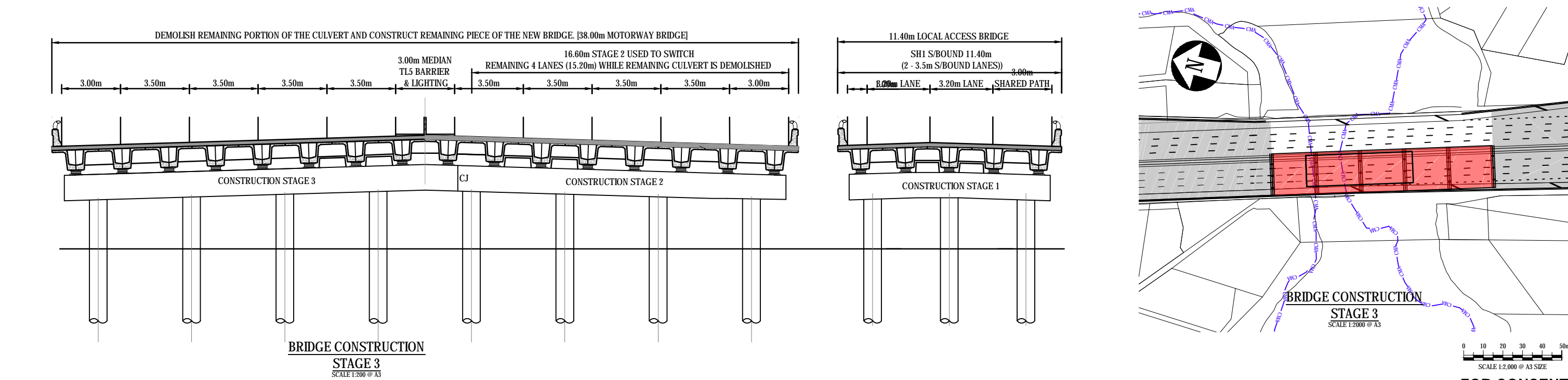
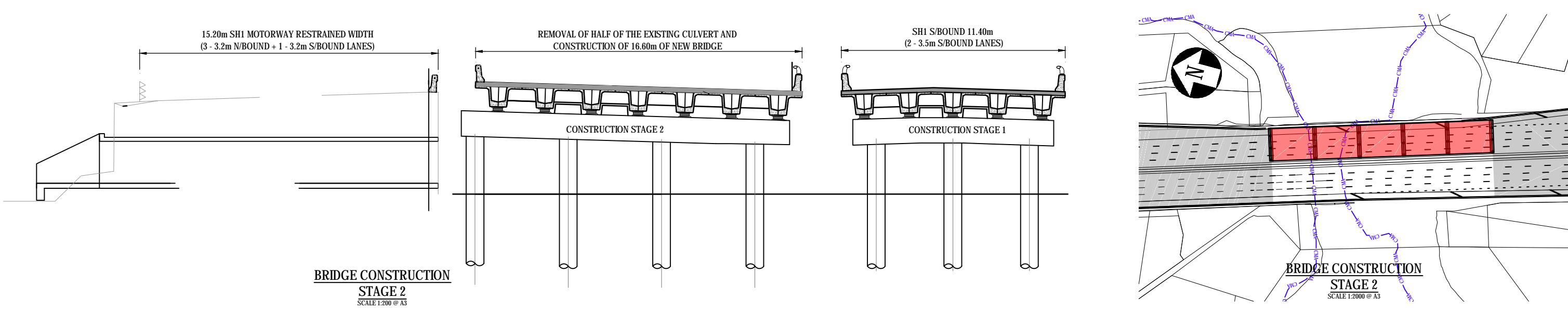
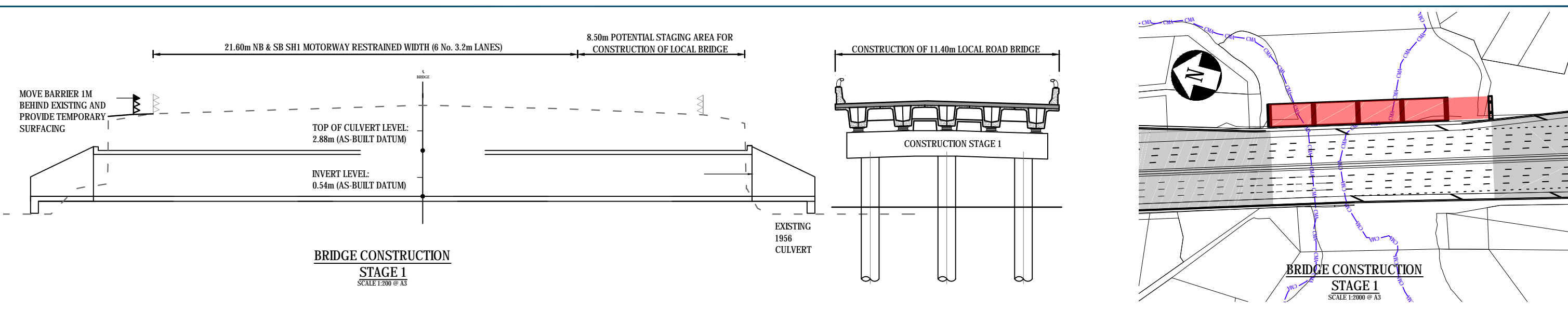

**FOR CONSENT**

0	ISSUED FOR CONSENT	AR	NN*	PK*	01/12/2016
No.	Issued Status	Drawn	Check'd	App'd	Date

**DISCLAIMER**  
This drawing is prepared under the Resource Management Act 1991 (RMA) for resource consent and designations. It is not to be used for any other purpose. Areas and measurements are subject to survey. Where the designs conflict with conditions the conditions will prevail. This Drawing must not be used for construction.

Drawn	A RAM	Drafting Check	J MURAHIDY	Reviewed Design Manager	N NANCEKIVELL	Approved Alliance Manager	P KELLY
Designed	L COLLINS	Design Check	J MURAHIDY		1/12/16		1/12/16
Scale:	Original Scale (A1)	Reduced Scale (A3)	AS SHOWN	Contract No	PA4014		

Drawing Title	CONSTRUCTION ACTIVITIES PLAN EAST WEST LINK - SH1/ OTAHUHU CREEK BRIDGE STAGING PLANS		
Drawing Number	AEE-CA-202	Rev No.	0



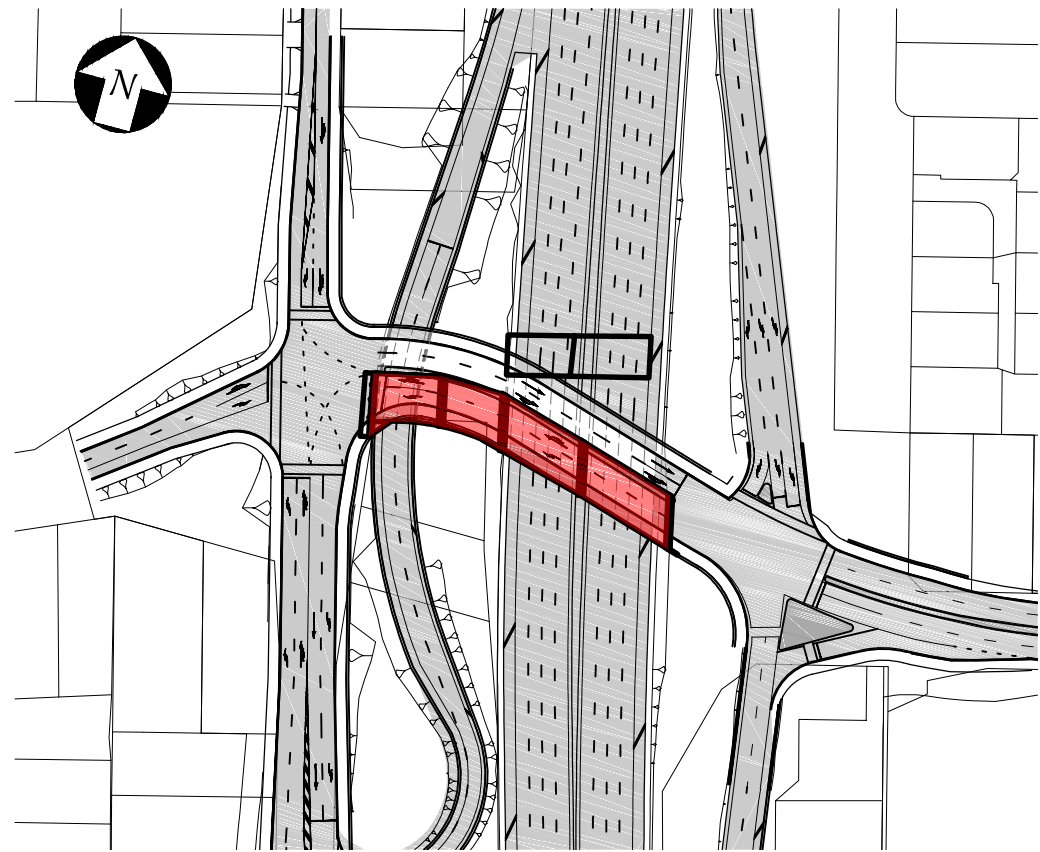

**BRIDGE CONSTRUCTION**  
**STAGE 1**  
SCALE 1:2000 @ A3

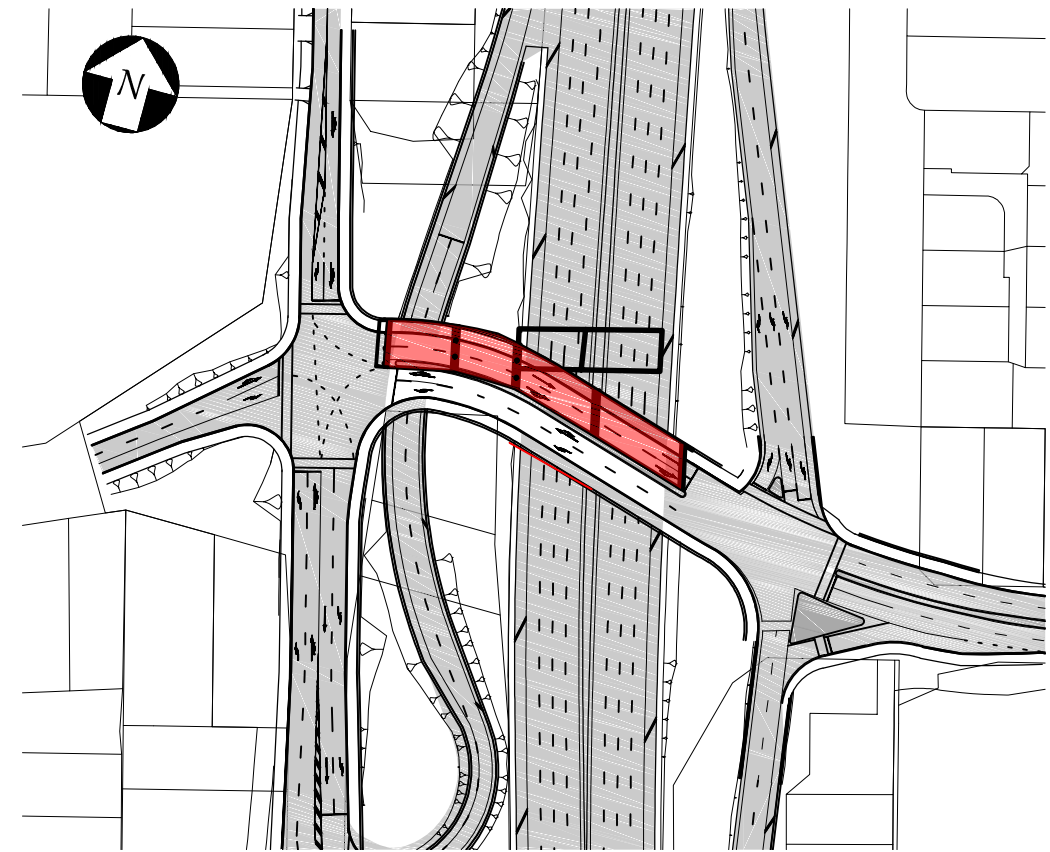

**BRIDGE CONSTRUCTION**  
**STAGE 2**  
SCALE 1:200 @ A3

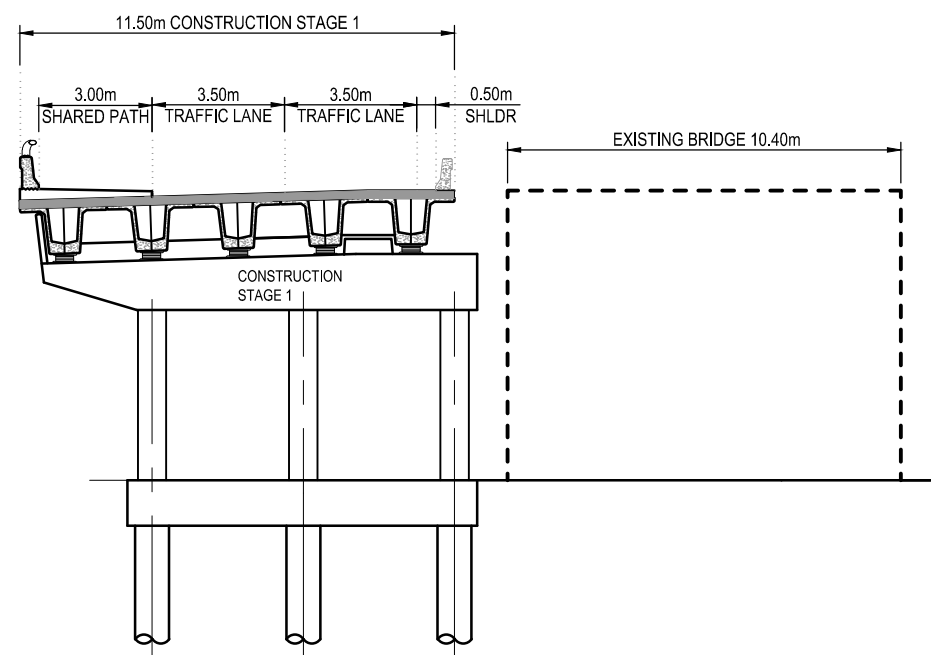

**STAGE 1: CONSTRUCT 11.5m OF NEW BRIDGE**

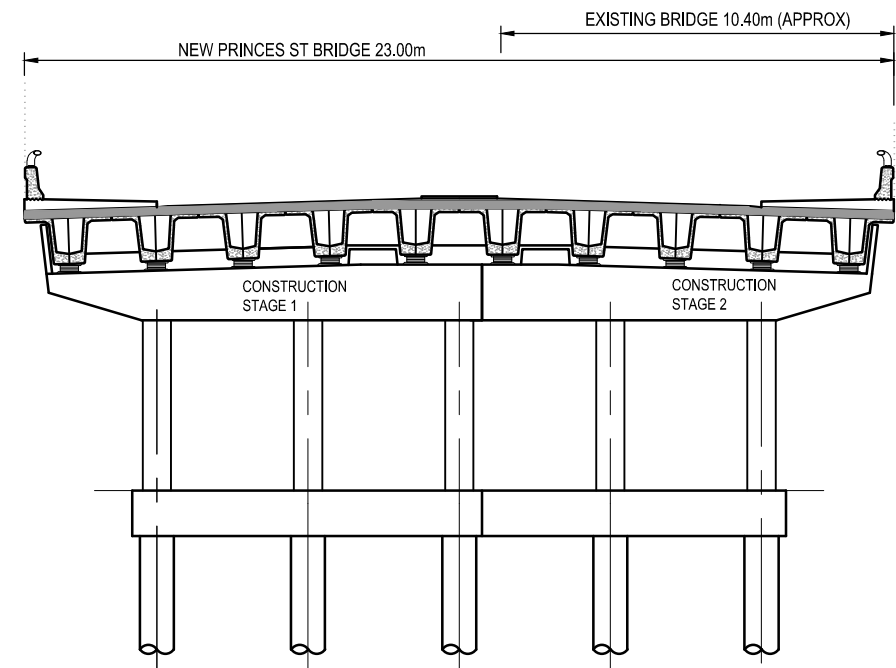

**STAGE 2: DECONSTRUCT EXISTING, CONSTRUCT REMAINING**

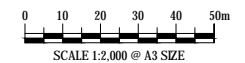

**FOR CONSENT**

0	ISSUED FOR CONSENT	AR	NN*	PK*	01/12/2016
No.	Issued Status	Drawn	Check'd	App'd	Date

**DISCLAIMER**  
This drawing is prepared under the Resource Management Act 1991 for resource consents and designations. Areas and measurements are subject to survey. Where the designs conflict with conditions the conditions will prevail. This Drawing must not be used for construction

Drawn	A RAM	Drafting Check	J MURAHIDY	Reviewed Design Manager	N NANCEKIVELL	Approved Alliance Manager	P KELLY
Designed	L COLLINS	Design Check	J MURAHIDY		1/12/16		1/12/16
Scale:	Original Scale (A1)	Reduced Scale (A3)	AS SHOWN	Contract No.	PA4014		

Drawing Title:	CONSTRUCTION ACTIVITIES PLAN EAST WEST LINK - PRINCES ST INTERCHANGE BRIDGE STAGING PLANS		
Drawing Number:	AEE-CA-203	Rev No.:	0