

SECTION B EQUIPMENT

B1 SIGNS

- B1.1 General
- B1.2 Sign Standards
 - B1.2.1 Level 1 Roads
 - B1.2.2 Level 2 and 3 Roads
- B1.3 Non-Standard, One-Off or Special Signs
- B1.4 Signs Used at Work Sites
 - B1.4.1 Advance Warning
 - B1.4.2 Direction and Protection
 - B1.4.3 End of Works
- B1.5 Application Date for Traffic Signs
- B1.6 Sign Supports and Stands
- B1.7 Application Date for Sign Supports and Stands

B2 DELINEATION DEVICES

- B2.1 General
- B2.2 Colour
- B2.3 Dimensions
- B2.4 Retro-Reflectivity
- B2.5 Application Date

B3 HIGH VISIBILITY GARMENTS

- B3.1 Fabric Compliance
- B3.2 Colour
- B3.3 Retro-Reflectivity
- B3.4 Garment Design
- B3.5 Logos
- B3.6 Site Traffic Management Supervisors (STMS) Garment
- B3.7 Compliance
- B3.8 Long Sleeve Garment
- B3.9 Exemption for Small Garments
- B3.10 Application Date

B4 LOGOS, NAMES AND TRADEMARKS

- B4.1 General
- B4.2 Area Requirements
- B4.3 Retro-Reflectivity

B5 PORTABLE TRAFFIC SIGNALS

- B5.1 Single Lane Signalised Alternating Flow
 - B5.1.1 General
 - B5.1.2 Power Supply
 - B5.1.3 Signal Displays
 - B5.1.4 Detection System
 - B5.1.5 Linking
 - B5.1.6 Controller
 - B5.1.7 Maintenance and Emergencies
 - B5.1.8 Types of Operation
 - B5.1.9 Timing of Signal Displays
 - B5.1.10 Start-up Sequence
 - B5.1.11 Flashing Yellow Mode
- B5.2 Haul Route Crossing
 - B5.2.1 Traffic Signal Design
 - B5.2.2 Modes of Operation
- B5.3 Signal Controlled Site Access
- B5.4 Application Date

B6 SAFETY FENCES

- B6.1 General
- B6.2 Design
- B6.3 Night Use
- B6.4 Application Date

B7 BARRICADES

- B7.1 General
- B7.2 Dimensions
- B7.3 Colour
- B7.4 Application Date

B8 ARROW BOARDS

- B8.1 General
- B8.2 Design
- B8.3 Size
- B8.4 Display Configurations
- B8.5 Location
- B8.6 Application Date

B9 VARIABLE MESSAGE SIGNS

- B9.1 General
- B9.2 Design
- B9.3 Sign Messages
- B9.4 Operation
- B9.5 Mounting of Sign
- B9.6 Application Date

B10 TRUCK MOUNTED ATTENUATORS (TMA)

- B10.1 Design
- B10.2 Vehicles
- B10.3 Application Date

B11 BARRIER SYSTEMS

- B11.1 General
- B11.2 Design
- B11.3 Colour
- B11.4 End Treatments
- B11.5 Channelling Traffic
- B11.6 Application Date

EXPLANATORY NOTE - Traffic Signs (Refer Section B1.1)

The Manual of Traffic Signs and Markings has been updated to include specifications for the new signs, including size, colour and fluorescent requirements. They are:

- The **first** advance warning sign, or pair of advance warning signs, at a temporary traffic management site on **Level 1** roads must have retro-reflective fluorescent orange material backgrounds. The minimum background requirement for all other temporary traffic management signs at the site is Class 1 standard retro-reflective material.
- All diamond shaped warning signs for **Level 1** roads must be at least 750 mm by 750 mm, with one diagonal vertical.
- All diamond shaped signs for **Level 2** and **Level 3** roads must be at least 850 mm X 850 mm, with one diagonal vertical and have retro-reflective fluorescent orange backgrounds.
- All diamond shaped warning signs on **Level 2** and **Level 3** roads must be located within a 1200mm x 1200mm square that has a white, at least Class 1 standard, retro-reflective background.

EXPLANATORY NOTE - Examples of Sign Sizes (Refer Section B1.2)

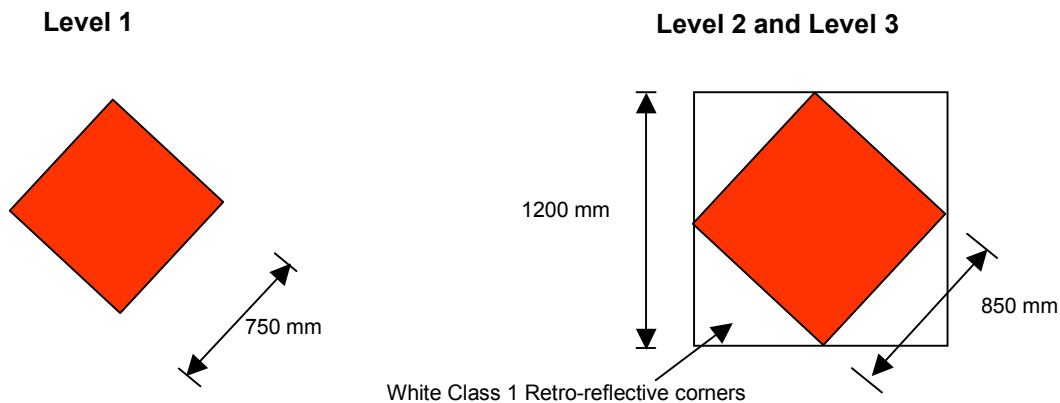

B1 SIGNS

B1.1 General

All signs must comply with the Transit New Zealand/LTSA Manual of Traffic Signs and Markings (MOTSAM) Parts 1 and 2, NZS 5414 and AS/NZS 1906.1:1993, except where modified by this Code. Where requirements are duplicated, AS/NZS 1906.1:1993 shall take precedence over NZS 5414.

All sign faces must have retro-reflective material backgrounds. Retro-reflective material must only be applied to substrates approved by the manufacturer and application methods must comply with the manufacturer's recommendations.

B1.2 Sign Standards

For details of temporary warning signs refer to MOTSAM-Part1, Section 5: Temporary Warning Signs.

For details of regulatory signs refer to MOTSAM-Part 1, Section 2: Regulatory Signs.

The first advance warning sign, or pair of advance warning signs, at a temporary traffic management site must have a retro-reflective fluorescent orange backgrounds.

The minimum standards for signs erected at temporary traffic management sites are specified in clauses B1.2.1 and B1.2.2.

B1.2.1 Level 1 Roads

(a) Warning Signs

All diamond shaped signs must conform with TW-A type sign details given in MOTSAM-Part 1, Section 5: Temporary Warning Signs. All rectangular shaped signs and Stop/Go paddles must also conform with sign details given in MOTSAM-Part 1, Section 5: Temporary Warning Signs.

The minimum size for a diamond shaped sign is 750 mm X 750 mm.

(b) Regulatory Signs

The minimum size for a regulatory sign shall be 750 mm diameter. 600 mm diameter signs may, however, be used for mobile operations. Where an RG 17 sign on the centre line of a two-way two-lane road is likely to pose a hazard due to insufficient lane widths, subject to the approval of RCA the alternative RG 17.1 sign may be used.

B1.2.2 Level 2 and 3 Roads

(a) Warning Signs

All diamond shaped signs must conform with TW-B type sign details given in MOTSAM-Part 1, Section 5: Temporary Warning Signs. All rectangular shaped signs and Stop/Go paddles must also conform with sign details given in MOTSAM-Part 1, Section 5: Temporary Warning Signs.

All diamond shaped signs on **Level 2** and **Level 3** roads shall have retro-reflective fluorescent orange backgrounds. The minimum size for a diamond shaped sign shall be 850mm X 850 mm and it must be superimposed on a white 1200 mm x 1200 mm square shaped backing board.

(b) Regulatory Signs

The minimum size shall be:

- Level 2** Roads: 1200 mm diameter for RG-4 signs
900 mm diameter for all other regulatory signs
750 mm diameter for Vehicle Mounted Signs
- Level 3** Roads: 1200 mm diameter for all regulatory signs
750 mm diameter for Vehicle Mounted Signs

Where an RG-17 sign on the centre line of a two-way two-lane road is likely to pose a hazard due to inadequate lane widths, subject to the approval of the RCA the alternative RG-17.1 sign may be used.

B1.3 Non-Standard, One-Off or Special Signs













Where it is considered necessary to provide additional signs for a special purpose and no approved design is available, the proposed signs shall be fully detailed on scale drawings and submitted for comment and approval with the TMP. The signs should comply with the following general temporary warning sign requirements:















- (a) Signs should be symbolic rather than in words wherever possible.
- (b) Where permanent warning sign legends/symbols are adopted for temporary traffic management purposes at work sites, the sign background should be specified as reflective orange rather than the retro-reflective yellow.
- (c) Additional direction signs should comply with the usual format used by the RCA. Letter sizes and spacing should match those on permanent sign faces and should be related to the vehicle approach speed at the sign location.
- (d) Approval must be obtained from the LTSA, in terms of the rules relating to experimental signs before any non-standard sign(s) can be erected at a temporary traffic management work site.

















B1.4 Signs Used at Work Sites















For the full sign use policies, and sign design details, refer to MOTSAM Part I: Traffic Signs, Section 2: Regulatory Signs and Section 5: Temporary Warning Signs.



B1.4.1 Advance Warning













Sign Reference and Description	Illustration	Requirements for Use
TW - 1 ROAD WORKS	 	This sign is erected at all attended work sites that are not specifically covered by TW-1."_" signs. The sign is also used at unattended work sites where there are hazards within 5 m of the edge line.
TW - 1B.1 ROAD WORKS <i>1 or 2 km</i>	 or 	This sign is used to give advance warning of major long-term work sites on Level 2 and Level 3 roads where there is a probability that a traffic queue will form. The distance shown shall normally be 1 km, ie. the distance between the sign and the start of the cone taper. If queues form back to the sign it shall be relocated 1 km further back and a distance of 2 km shown.
TW - 1B.2 ROAD WORKS <i>1 or 2 km DELAYS POSSIBLE</i>		This sign is used to give advance warning of major long-term work sites on Level 2 and Level 3 roads, where there is a probability that a traffic queue will form and that some delays are also likely. The distance shown shall normally be 1 km, ie. the distance between the sign and the start of the cone taper. If queues form back to the sign it shall be relocated 1 km further back and a distance of 2 km shown.
TW - 1B.3 ROAD WORKS <i>"_" 0 km/h AHEAD</i>		This sign is a TW-1 ROAD WORKS sign with a supplementary plate to give advance warning of a temporary speed restriction. It is used on Level 2 and Level 3 roads and the speed shown must be the same as the temporary speed limit imposed at the work site.
TW - 1.1 ROAD WORKS <i>NEXT "_" km</i>	 	This sign is a TW-1 ROAD WORKS sign with a supplementary plate indicating the extent of the road works. The sign is used where any type of work has resulted in a road surface inferior to that on the approaches and extends for more than 1 km.
TW - 1.2 ROAD WORKS <i>NEW SEAL WET TAR</i>	   	This sign is a TW-1 ROAD WORKS sign with an alternative supplementary plate. The NEW SEAL supplementary plate is used to indicate sealing operations and a newly sealed surface while it is susceptible to damage by motor traffic. The WET TAR supplementary plate is used to indicate bleeding of a completed seal, new or otherwise.

Sign Reference and Description	Illustration		Requirements for Use
<p>TW - 1.3 ROAD WORKS</p> <p><i>SPECIALIST MOBILE PLANT</i></p>	 	 	<p>This sign is a TW-1 ROAD WORKS sign with a supplementary plate indicating that there is maintenance plant operating on the roadway or within 5 m of the edge line. The signs shall not be used for mobile operations such as patching where people are working on the road.</p> <p>Where the maintenance operation is outside the roadway but within 5 m of the edge line the TW-1.3 sign may be erected to warn road users approaching on the affected side only. Where the maintenance operation is on the roadway TW-1.3 signs must be erected on both approaches to the work site.</p>
<p>TW - 1.4 ROAD WORKS</p> <p><i>ROAD MARKING</i></p>			<p>This sign is a TW-1 ROAD WORKS sign with a supplementary plate indicating that road marking is being carried out.</p>
<p>TW - 1.5 ROAD WORKS</p> <p><i>ON SIDE ROAD</i></p>			<p>This sign is a TW-1 ROAD WORKS sign with a supplementary plate indicating that there is a work site on a side road. The sign is used where the side road work area is too close to the intersection to meet the visibility criteria for advance warning signs.</p>
<p>TW - 1.6 ROAD WORKS</p> <p><i>SHOULDER CLOSED</i></p>			<p>This sign is a TW-1 ROAD WORKS sign with a supplementary plate indicating that the shoulder is temporarily closed by some road works activity.</p>
<p>TW - 1.7 ROAD WORKS</p> <p><i>SURVEYING</i></p>			<p>This sign is a TW-1 ROAD WORKS sign with a supplementary plate SURVEYING. The sign shall only be displayed when the survey party is actually on the roadway or within 5 m of the edge line.</p>
<p>TW - 1.8 ROAD WORKS</p> <p><i>BRIDGE REPAIRS</i></p>			<p>This sign is a TW-1 ROAD WORKS sign with a supplementary plate BRIDGE REPAIRS indicating that maintenance work is being undertaken on a bridge.</p>

Sign Reference and Description	Illustration		Requirements for Use
<p>TW - 2.1 OTHER HAZARD <i>FLOODING</i></p>			<p>This sign is used wherever surface water on the roadway creates a hazard. A depth of a few centimetres can be dangerous.</p>
<p>TW - 2.2 OTHER HAZARD <i>WASHOUT</i></p>			<p>This sign is used wherever a portion of road has eroded or fallen away and reduced the road width available to traffic. Edge marker posts or temporary delineation devices should be used to indicate the edge of the useable roadway.</p>
<p>TW - 2.3 OTHER HAZARD <i>LINEMEN</i></p>			<p>This sign should only be used when people or machines are working on overhead lines or poles within 5 m of the edge line.</p>
<p>TW - 2.4 OTHER HAZARD <i>BLASTING</i></p>			<p>This sign is used to indicate blasting operations in hand on or near the road and where there is a danger to road users from flying debris. Manual Traffic Controllers using TW-33 STOP / GO PADDLES together with TW-15.1 MANUAL TRAFFIC CONTROL signs must be employed on all road approaches in conjunction with the TW-2.4 signs, to prevent traffic entering the danger area for the duration of each danger period.</p>
<p>TW - 2.5 OTHER HAZARD <i>TREE FELLING</i></p>			<p>This sign should be used to indicate tree trimming and/or felling operations are being carried out on or near the road and there is a danger to road users from falling branches or trees. Manual Traffic Controllers using TW- 33 STOP / GO PADDLES together with TW-15.1 MANUAL TRAFFIC CONTROL signs must be employed on all road approaches in conjunction with the TW-2.5 signs, to prevent traffic entering the danger area for the duration of each danger period.</p>
<p>TW - 2.6 OTHER HAZARD <i>LOGGING TRUCKS</i></p>			<p>This sign is used in situations where logging truck movements occur to and from a road over relatively short period (typically four to six weeks) while small forestry blocks are being logged. The signs shall be covered or removed overnight or when logging operations are suspended for more than four hours</p>
<p>TW - 2.7 OTHER HAZARD <i>TRUCKS CROSSING</i></p>			<p>This sign used where a large number of heavy commercial vehicles are required to turn into and out of a site. The signs should not be used in urban areas or at road works sites and shall be covered or removed overnight.</p>
<p>TW - 2.8 OTHER HAZARD <i>NO ROAD MARKING</i></p>			<p>This sign is used in situations where road markings have been obliterated due to road work operations such as pavement water blasting or cutting and where use of the TW-5.1 NEW SEAL sign is inappropriate because it displays flying stones and a broken windscreen.</p>

Sign Reference and Description	Illustration		Requirements for Use
<p>TW - 2.9 OTHER HAZARD <i>SIGNALS CHANGED</i></p>			<p>This sign is installed in advance of an intersection where the traffic signal control sequence has been changed. The sign must be erected for a minimum of two weeks following the change in control.</p>
<p>TW - 2.10 OTHER HAZARD <i>SIGNALS NOT WORKING</i></p>			<p>This sign is used when a traffic signal is not operational because of a fault or maintenance work. The sign is not required when traffic signals are operating in the amber flashing mode.</p>
<p>TW - 2.11 OTHER HAZARD <i>NEW ROAD LAYOUT</i></p>			<p>This sign is installed in advance of a change to the road, or an intersection, layout. The sign must be erected for a minimum of two weeks following the change.</p>
<p>TW - 2.12 OTHER HAZARD <i>TRAFFIC SURVEY</i></p>			<p>This sign is used on the approaches to roadside traffic survey sites for the duration of survey. Each TW-2.12 sign is to be augmented with a TW-18 PLEASE STOP ON REQUEST sign and a TW-16 THANK YOU sign is to be erected downstream of the survey site.</p>
<p>TW - 2.13 OTHER HAZARD <i>VULNERABLE ROAD USER EVENT</i></p>			<p>This sign is used for events involving vulnerable road users, ie. cyclists, runners and walkers. The signs are to be erected on stands, as for static operations, to warn road users of the event.</p>
<p>TW - 2.14 OTHER HAZARD <i>ACCIDENT</i></p>			<p>This sign should be used whenever any traffic management measures are implemented at a crash site.</p>
<p>TW - 2.15 OTHER HAZARD <i>FIRE</i></p>			<p>This sign should be used whenever fire fighting operations and/or drifting smoke presents a hazard to normal traffic operations.</p>

Sign Reference and Description	Illustration	Requirements for Use
<p>TW - 2.16 OTHER HAZARD <i>(vehicle mounted only)</i></p> <p><i>VULNERABLE ROAD USERS AHEAD</i></p>		<p>This sign is used for long distance events involving vulnerable road users. The sign is erected on pilot vehicles accompanying the event to warn approaching and following drivers to indicate that there are cyclists, runners or walkers on the road ahead.</p>
<p>TW - 2.17 OTHER HAZARD</p> <p><i>FUNERAL</i></p>		<p>This sign may be used in advance of a site where it is likely that funeral activities will present a hazard to normal traffic operations.</p>
<p>TW - 2.18 OTHER HAZARD</p> <p><i>FILM CREW</i></p>		<p>This sign may be used in advance of a site where it is likely that film making activities will present a hazard to normal traffic operations.</p>

Sign Reference and Description	Illustration		Requirements for Use
<p>TW - 3 SLIPS</p>			<p>This sign should be used wherever slips or other fallen debris affects part of the roadway.</p>
<p>TW - 4 SLIPPERY SURFACE</p>			<p>This sign should be used where road construction or maintenance machines carry clay or other materials onto the roadway surface, which consequently may temporarily become greasy when wet.</p> <p>A PW-41.2 SLIPPERY SURFACE WHEN WET sign should be used where other surface defects not of a temporary nature cause the road surface to become slippery when wet.</p>
<p>TW - 4.1 SLIPPERY SURFACE <i>ICE / GRIT</i></p>			<p>This sign is used when grit is spread onto the roadway surface when ice forms. Additional TW-4.1 signs, spaced no more than 2 km apart, should be erected along sections of road when grit has been spread on the roadway surface when ice forms. Where several such sections of road occur in close proximity the first TW-4.1 sign may be augmented with an additional supplementary plate NEXT " _ " km. Where a TW-4.1 sign is to be erected near a PW-41.1 SLIPPERY SURFACE - WHEN FROSTY sign it should be located past the PW-41.1 sign by approximately 20 to 50 m and in such a position that both signs will be visible at the same time to an approaching road user.</p>
<p>TW - 5 GRAVEL SURFACE</p>			<p>This sign should be used when a section of normally sealed road temporarily has a gravel surface. Because this is a more specific warning than the TW-1 ROAD WORKS sign it should be used in preference to that sign whenever the main hazard is a gravel surface. The sign should be replaced with TW-5.1 GRAVEL SURFACE - NEW SEAL signs as soon as the surface has been resealed.</p>
<p>TW - 5.1 GRAVEL SURFACE <i>NEW SEAL</i></p>			<p>This sign should be used as soon as new sealing work has been completed and shall remain in position until all loose chip has been removed and new pavement markings have been installed.</p>
<p>TW - 5.2 GRAVEL SURFACE <i>SEAL REPAIRS</i></p>			<p>This sign is used for multiple seal repair patches along a section of road less than 1 km in length.</p> <p>Where the length of road under repair is greater than 1 km TW-5.2 sign must be repeated every 1 km.</p> <p>Where several such sections of road occur in close proximity the first TW-5.2 sign may be augmented with a TW-1.1 NEXT " _ " km sign.</p>





















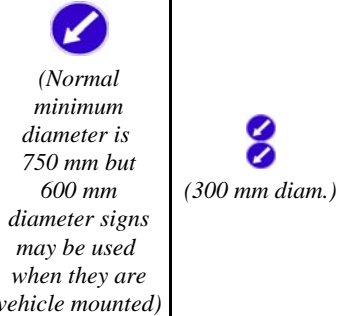

Sign Reference and Description	Illustration		Requirements for Use
<p>TW - 6 / TW - 6.1 STOCK - TEMPORARY <i>CATTLE / SHEEP</i></p>			<p>This sign should be used where driven stock crosses, or travels short distances along the road at infrequent intervals (greater than 2 days) and in such a location as to cause a traffic hazard. The signs should only be displayed when stock is actually within the road reserve.</p> <p>When the frequency of stock movements is greater (on a regular daily basis - often perhaps several times a day) or, where the lack of fences, walls etc. along the road reserve results in continual presence of stock on the road PW-37 (PW-37.1) STOCK signs should be used.</p>
<p>TW - 26 ROAD WORKS <i>(vehicle mounted only)</i></p>			<p>This sign must be used in conjunction with vehicle mounted flashing yellow lights and must be mounted on the front of the lead pilot vehicle of all mobile operations.</p>
<p>TW - 27 ROAD INSPECTION <i>(vehicle mounted only)</i></p>			<p>This sign must be used in conjunction with vehicle mounted flashing yellow lights and must be mounted on the rear of any vehicle conducting road inspections.</p>
<p>TW - 35 DIVERGE</p>			<p>This sign may be used within a road work site where traffic lanes in the same direction are required to pass either side of a hazard.</p> <p>NOTE: TW - 35 signs MUST never be used for centre lane closures.</p>
<p>TW - 36 UNEVEN SURFACE</p>			<p>This sign should be used where road surface deformation constitutes an additional hazard at a road works site.</p>

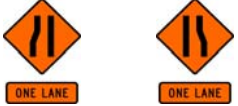

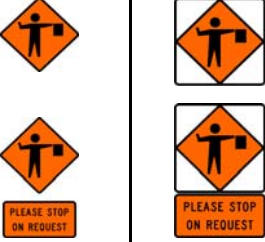

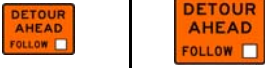

Table B1.1: Advance Warning Signs

B1.4.2 Direction and Protection

Sign Reference and Description	Illustration	Requirements for Use
<p>RG - 4 SPEED LIMIT <i>TEMPORARY</i></p>		<p>These signs are used to restrict traffic speeds at work sites to give protection to workers, the road surface and road structures in an emergency. The temporary speed limit must be at least 20 km/h less than the normal speed limit for that section of road.</p>
<p>RG - 7 NO RIGHT TURN</p>	 <p>(750 mm minimum diam.)</p>	<p>These signs are used to stop traffic turning into a hazard area.</p>
<p>RG - 8 NO LEFT TURN</p>	 <p>(750 mm minimum diam.)</p>	
<p>RG - 16 ROAD CLOSED</p>	 <p>(750 mm minimum diam.)</p>	<p>This sign can only be used after formal authorisation by the controlling authority that the road is closed to ordinary vehicular traffic for the purposes of facilitating road works or any other legitimate activity.</p> <p>RG-16 signs must be augmented with TW-1 ROAD WORKS signs and TW-22 DETOUR DIRECTION INDICATOR signs used to indicate the shortest alternative route with an adequate width and no height restrictions.</p>
<p>RG - 17 / RG - 17.1 KEEP LEFT <i>SINGLE DISK / TWIN DISK</i></p>		<p>RG-17 and RG-17.1 signs are used to indicate to that drivers must pass to the left of an obstruction or that the traffic lane(s) shift to the left.</p>
<p>RG - 19.1 SINGLE LANE GIVE WAY</p>	 <p>(750 mm minimum diam.)</p>	<p>RG-19.1 signs must be used in conjunction with RG-20 SINGLE LANE - PRIORITY and TW-13 ONE LANE signs. The sign is used where a two-lane two-way road has been reduced to a single lane through a work site or by a temporary hazard.</p> <p>RG-19.1 signs should be erected in advance of the single lane section of road and on the approach where drivers have the best visibility through the single section and hence are in the best position to assess whether they must 'give way' to oncoming traffic or may proceed if the road is clear.</p>

Sign Reference and Description	Illustration	Requirements for Use
<p>RG - 20 SINGLE LANE PRIORITY</p>	 <p>(560 mm x 625 mm minimum)</p>	<p>RG-20 signs must be used in conjunction with RG-19.1 SINGLE LANE - GIVE WAY and TW-13 ONE LANE signs. The sign is used where a two-lane two-way road has been reduced to a single lane through a work site or by a temporary hazard.</p> <p>RG-20 signs should be erected in advance of the single lane section of road and on the approach considered most appropriate for assigning the priority traffic movement.</p>
<p>RG - 34 KEEP RIGHT</p>	 <p>(Normal minimum diam. 750 mm, 600 mm diam. when vehicle mounted)</p>	<p>RG-34 signs are used to indicate that drivers must pass to the right of an obstruction or that the traffic lane shifts to the right.</p>
<p>RP - 1.1 (L/LR/R) NO STOPPING AT ALL TIMES</p> <p>(urban and road works situations)</p>	 <p>(350 mm x 500 mm minimum)</p>	<p>These signs are used where parked vehicles could restrict traffic flows through a road works or temporary hazard site.</p>
<p>TW - 7 (L/R) LANE CLOSED</p> <p>TWO LANE ONE WAY ROAD</p>	 	<p>This sign is used when the left or right lane is closed on two-lane one-way carriageway.</p> <p>A supplementary distance plate is used for signs on Level 2 and Level 3 roads.</p>
<p>TW - 7.1 (L/R) LANE CLOSED</p> <p>THREE-LANE ONE-WAY ROAD</p>	 	<p>This sign is used when the left or right lane is closed on three-lane one-way carriageway.</p> <p>A supplementary distance plate is used for signs on Level 2 and Level 3 roads.</p>
<p>TW - 7.1.1 (L/R) CENTRE LANE CLOSED</p> <p>THREE-LANE ONE-WAY ROAD</p>	 	<p>This sign may be used for a centre lane closure on three-lane one-way carriageway, <i>where the speed limit is 50 km/h or less.</i></p> <p>A supplementary distance plate is used for signs on Level 2 and Level 3 roads.</p>

Sign Reference and Description	Illustration	Requirements for Use
<p>TW - 7.2 (L/R) LANE CLOSED</p> <p><i>FOUR-LANE ONE-WAY ROAD</i></p>		<p>This sign is used when the left or right lane is closed on four-lane one-way carriageway.</p> <p>A supplementary distance plate is used for signs on Level 2 and Level 3 roads.</p>
<p>TW - 8 (L/R) LANE SHIFT</p> <p><i>TWO-LANE ONE-WAY ROAD</i></p>		<p>This sign is used on a two-lane one-way carriageway to indicate that the road ahead is temporarily shifted off its normal alignment.</p> <p>A supplementary distance plate is used for signs on Level 2 and Level 3 roads.</p>
<p>TW - 8.1 (L/R) LANE SHIFT</p> <p><i>THREE-LANE ONE-WAY ROAD</i></p>		<p>This sign is used on a three-lane one-way carriageway to indicate that the road ahead is temporarily shifted off its normal alignment.</p> <p>A supplementary distance plate is used for signs on Level 2 and Level 3 roads.</p>
<p>TW - 9 MERGING TRAFFIC</p> <p><i>MAIN ROAD</i></p>		<p>This sign is used on Level 2 and Level 3 roads when one or more lanes on the main road are closed and the normal on ramp taper has been extended to the lanes remaining open to traffic.</p>
<p>TW - 10 MERGING TRAFFIC</p> <p><i>SIDE ROAD</i></p>		<p>This sign is used on on ramps to Level 2 and Level 3 roads when one or more lanes on the main road are closed.</p>
<p>TW - 11 ADVANCE EXIT</p>		<p>This sign is used on Level 2 and Level 3 roads when one or more lanes on the main road are closed and the normal off ramp taper has been extended to the lanes remaining open to traffic.</p>
<p>TW - 12 EXIT DIRECTION</p>		<p>This sign is normally only used on multilane divided carriageway roads where one or more of the main road lanes have been closed and an off ramp exit lane has been extended to meet the lane remaining open to traffic. The sign replaces the standard MI-3 EXIT off ramp gore area sign in these situations.</p>

Sign Reference and Description	Illustration	Requirements for Use
<p>TW - 13 (L/R) ONE LANE</p> <p><i>ONE SIDE NARROWING</i></p>		<p>These signs may only be used on two-lane two-way roads with an AADT of less than 1000 vpd where the road is effectively reduced to a single lane.</p> <p>TW-13 and TW-13.1 signs must be augmented with RG-19.1 SINGLE LANE - GIVE WAY signs and RG.20 SINGLE LANE - PRIORITY signs.</p>
<p>TW - 13.1 ONE LANE</p> <p><i>BOTH SIDES NARROWING</i></p>		
<p>TW - 14 TRAFFIC SIGNALS</p> <p><i>TEMPORARY</i></p>		<p>This sign is used and normally only used on two-lane two-way roads to provide advance warning of temporary traffic signals at a work site.</p> <p>TW-14 signs must be augmented with TW-1 ROAD WORKS signs and RG-4 SPEED LIMIT - TEMPORARY signs (30km/h or less).</p>
<p>TW - 15 TW - 15.1 MANUAL TRAFFIC CONTROL</p>		<p>These signs are normally only used at work sites on two-lane two-way roads to provide advance warning of manual traffic control using TW-33 STOP / GO PADDLES.</p> <p>TW-15 and TW-15.1 signs must be augmented with TW-1 ROAD WORKS signs and RG-4 SPEED LIMIT - TEMPORARY signs (30km/h or less).</p>
<p>TW - 18 PLEASE STOP ON REQUEST</p>		<p>This sign is used in advance of the TW-2.12 TRAFFIC SURVEY sign and also as a supplementary plate to the TW-15 MANUAL TRAFFIC CONTROL sign to form the TW-15.1 sign combination.</p>
<p>TW - 20 ROAD/EXIT CLOSED AHEAD</p>		<p>This sign is used where the road or motorway/expressway exit ahead is closed. In normal circumstances an alternative route or detour will also be provided.</p>
<p>TW - 21 DETOUR AHEAD</p> <p><i>FOLLOW "symbol"</i></p>		<p>This sign is used to indicate the start of a detour route.</p>
<p>TW - 22 DETOUR DIRECTION INDICATOR</p> <p><i>TW - 22 (L/R)</i> <i>TW - 22.1 (L/R)</i> <i>TW - 22.2 (L/R)</i></p>		<p>These signs are used to indicate a detour route, changes of direction of the route and also confirmation of the route where the direction might not be clear to drivers, eg. at intersections.</p>
<p>TW - 25 PILOT CAR FOLLOW ME</p> <p><i>(vehicle mounted only)</i></p>		<p>This sign is attached to the rear or roof of a pilot vehicle which used to lead traffic through a work site at a desired speed.</p> <p>TW- 25 signs should be used in conjunction with Manual Traffic Controllers using TW-33 STOP / GO PADDLES.</p>

Sign Reference and Description	Illustration	Requirements for Use
<p>TW - 28 (L/R) SITE ACCESS " _ "00 m</p>		<p>This sign may be erected to give advance warning of an approved access point to a work site located adjacent to the road, when the site access is directly off a live lane on that road.</p>
<p>TW - 29 (L/R) SITE ACCESS <i>DIRECTION INDICATOR</i></p>		<p>This sign may be erected at the approved access to a work site located adjacent to the road when the site access is directly off a live traffic lane on that road.</p>
<p>TW - 30 CROSSING CLOSED PLEASE USE ALTERNATIVE CROSSING</p>		<p>This sign is used where a formal pedestrian crossing place is no longer available because of road works or some other temporary type work activity. TW-32 PEDESTRIAN DIRECTION signs must be used to direct pedestrians to another formal crossing point.</p>
<p>TW - 31 FOOTPATH CLOSED PLEASE USE OTHER SIDE</p>		<p>This sign is used where a formal footpath cannot be used because of road works or some other temporary type work activity and there is an alternative footpath on the other side of the road. TW-31 signs must not be used on roads with a speed limit greater than 65 km/h or on Level 2 and 3 roads.</p>
<p>TW - 32 PEDESTRIAN / CYCLIST DIRECTION <i>TW - 32P or C (L/R)</i> <i>TW - 32.1P or C (L/R)</i> <i>TW - 32.2P or C (L/R)</i></p>		<p>These signs are used to guide pedestrians / cyclists to a temporary route or formal crossing point, and indicate the alignment of the temporary route, when the normal facility is not useable due to road works or some other temporary activity.</p>
<p>TW - 33 STOP / GO PADDLE</p>		<p>These signs may only be used by personnel that have training to the level of traffic management required by Manual Traffic Controllers (MTC's) at the particular work site. TW-1 ROAD WORKS, TW-15.1 MANUAL TRAFFIC CONTROL and RG-4 SPEED LIMIT - TEMPORARY signs (30 km/h or less) must be used in conjunction with Manual Traffic Controllers using TW-33 STOP / GO PADDLES.</p>
<p>TW - 34 (L/R) PASS WITH CARE <i>(vehicle mounted only)</i></p>	<p><i>(RG - 34L sign 600 mm diam.)</i> <i>(RG - 34R sign 600 mm diam.)</i></p>	<p>PW-34 signs may be substituted for the relevant TW sign required to be mounted on the rear of shadow and work vehicles involved in temporary mobile operations. The RG-17 or RG-34 sign may be omitted when the vehicle is fitted with an arrow board.</p>

Table B1.2: Regulatory and Direction Signs

B1.4.3 End of Works













Sign Reference and Description	Illustration	Requirements for Use
RG - 1 SPEED LIMIT	 (750 mm minimum diam.)	These signs are used to de-restrict traffic after passing the work site.
RG - 2 RG - 2.1 SPEED LIMIT <i>100 / DERESTRICTION</i>	 (750 mm minimum diam.)	The sign must be placed opposite the RG-4 sign on two-way two-lane roads. On one-way carriageways a TW-16 WORKS END sign is attached as a supplementary plate and placed at the appropriate sign spacing distance past the work site or other hazard area.
TW - 16 WORKS END	 	This sign is used to indicate the end of a work site that has TW-1 type advance warning signs.
TW - 17 THANK YOU	 	This sign is used to indicate the end of an other hazard area indicated with TW-2 type advance warning signs and also work sites indicated with TW-3, TW-4, TW-5 and TW-6 advance warning signs.
TW - 16/17 WORKS END THANK YOU	 	This sign combination may be used to indicate the end of any work site or other hazard area when the controlling authority considers the combined message is desirable.
TW - 19 DRY YOUR BRAKES	 	This sign is used to indicate the end of a section of road that has been signed with TW-2.1 FLOODING advance warning signs.
TW - 23 DETOUR ENDS		This sign is used to indicate the end of a temporary detour route.
TW - 24 CEMENT SPLASHES WASH CAR TODAY		These signs are used to augment other signs at road work sites where lime or cement stabilisation is being undertaken and vehicles travelling on a saturated pavement can become contaminated with lime or cement splashes. The signs are not usually be required under dry working conditions.
TW - 24.1 LIME SPLASHES WASH CAR TODAY		

Table B1.3: End of Works Signs

B1.5 Application Date for Traffic Signs

All traffic signs used for temporary traffic management must comply with the requirements of this Code of Practice:

B1.6 Sign Supports and Stands

Sign supports and stands must be designed to ensure they:

- will not cause significant damage to a vehicle if struck by one,
- are stable under all reasonably expected weather conditions and air turbulence from passing traffic, and
- will not present a hazard to vehicles, including bicycles, after being knocked or falling over, ie the sign, its support and stand must lie relatively flat with no part more than 150mm above the ground surface.

Sandbagging is an effective method of securing signs. Signs may not be secured by hanging a weight from any part of the sign. Concrete and heavy steel (truck wheel rims, welded water pipe, etc) must not be used as a base for signs. Signs may be secured by pinning the base of the support to the ground with U-bolt type anchors subject to prior approval by the RCA. There is a risk of cable strike associated with this method and this Code of Practice discourages this practice.

Where ballast is used on a sign stand or base it must:

- be designed so that it **cannot** roll;
- be constructed from hessian, rubber or plastic bags containing a soft granular or liquid material, and
- be no higher than 300mm above ground level.

Sign stands must:

- be designed so they **cannot** roll,
- have a low profile base, ie. be no higher than 150mm above the ground surface, and
- be designed to break away from the rest of the sign support system on impact.

B1.7 Application Date for Sign Supports and Stands

All sign supports and stands for temporary traffic management must comply with the requirements of this Code of Practice from the following dates:

Level LV and 1	1 July 2005
Level 2 and 3	1 July 2006

This page is intentionally blank

EXPLANATORY NOTE - Base Shape and Design (Refer Section B2.2)

Delineation devices with square rather than circular bases will not roll when knocked over. Other designs may also ensure delineation devices do not roll.

B2 DELINEATION DEVICES

B2.1 General

Delineation devices such as cones, tubular delineators and barrels, must be specifically designed and manufactured for temporary traffic management use.

B2.2 Colour

All delineation devices, e.g. cones, tubular delineators and barrels, must be fluorescent orange with:

- CIE chromaticity co-ordinates in accordance with Table 2.1 of the joint Australian and New Zealand Standard AS/NZS 1906.4:1997;
- Minimum luminance factors in accordance with Table 2.2 of the joint Australian and New Zealand Standard AS/NZS 1906.4:1997.

In addition, the internal colour of the bases of cones, tubular delineators and barrels must be either white or fluorescent orange, to ensure the device remains visible if knocked over.

B2.3 Dimensions

On *all Levels* of roads the cones, tubular delineators and barrels used for delineation purposes must have a minimum height of 900mm and an unballasted weight not exceeding 7kg.

- Notes:**
1. 450 mm high cones may only be used to delineate and protect wet road markings.
 2. Double stacking of cones is not acceptable as such practice will exceed the maximum permitted weight and is prohibited, with effect from 31 July 2005.
 3. In locations where high wind speed is a concern heavier weight cones, up to 7kg, of a 'slimline' profile should be used.

All cones must:

- be sufficiently stable to remain upright in service,
- have a base designed to stop the cone from rolling if knocked over, and
- be capable of returning to their original shape after impact.

All barrels must have:

- a minimum base dimension of 600mm x 600mm,
- rectangular or slightly chamfered corners, and
- a stable base design that will accommodate either sandbags or water as ballast.

EXPLANATORY NOTE - Retro-Reflective Band Set Out (Refer Section B2.4)

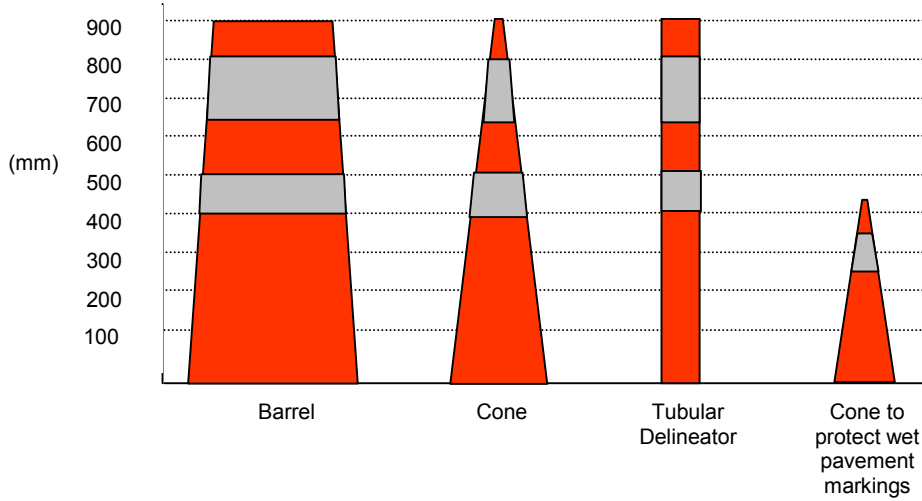

Barrels used for temporary traffic management must not:

- be made of steel,
- be weighted with any material that could be a hazard if struck,
- have ballast placed on top of the barrel, and
- be filled with water where below freezing conditions are expected.

All tubular delineators must:

- be at least 100mm wide.

B2.4 Retro-Reflectivity

Delineation devices must have white retro reflective bands that:

- meet the requirements for Class 1 material in Table 2.1 of the joint Australian and New Zealand Standard AS/NZS 1906.1:1993, and
- conform to the number, width and height requirements of Table B2.1.

Size (mm)	Use	No. Bands	Band Width (mm)	Height of bottom edge of band from ground (mm)
900	All roads	2	100	400 (1 st band)
			150	650 (2 nd band)
450	To protect freshly painted road markings	1	100	250

Table B2.1: Retro Reflective Bands for Delineation Devices

B2.5 Application Date

All delineation devices must comply with the above requirements.

EXPLANATORY NOTE - Examples of Complying Clothing (Refer Section B3.4)

Other garments such as jackets with sleeves or overalls can also be used as long as they comply with the colour, retro-reflectivity and design requirements.

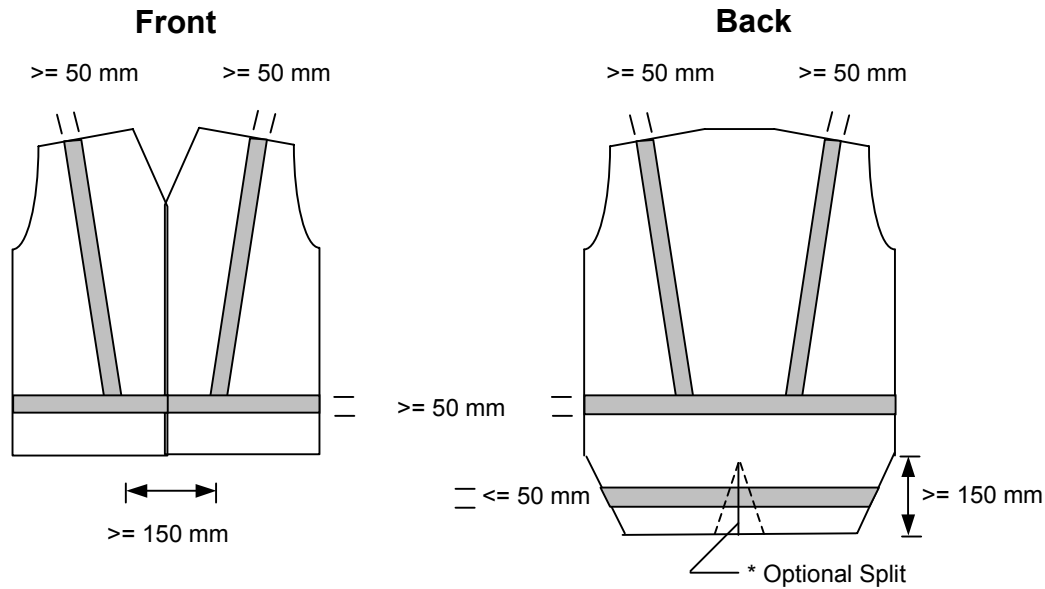

Jackets and other clothing shall always be done up when being worn on a work site.

*** Optional Split:**

- This feature may be included if there is a danger that the garment could snag when the wearer alights from any construction equipment. However, good practice dictates that when alighting from any construction equipment the operator should be facing the vehicle.
- Where a rear split is included in a garment an overlap must be provided and it is recommended that Velcro, or an equivalent rip/tear product secures the split.

B3 HIGH VISIBILITY GARMENTS

B3.1 Fabric Compliance

All fabric used in the manufacture of the garment shall comply with the joint Australian and New Zealand standard for fabric compliance, AS/NZS 1906.4:1997: High Visibility Materials for Safety Garments.

B3.2 Colour

The background fabric shall be fluorescent red orange conforming with the requirements of Table 2.1 in the joint Australian and New Zealand standard AS/NZS 1906.4:1997. It should be noted that the measurement for fluorescence is made over a black background so that some open mesh fabrics may not comply.

B3.3 Retro-Reflectivity

The retro-reflective fabric shall comply with the specification "R" fabric as noted in Table 3.2 of the joint Australian and New Zealand standard AS/NZS 1906.4:1997. Where retro-reflective material also meets the standard for fluorescence required by Table 2.1 in the joint standard, the area of this material may also be included when assessing daytime compliance.

B3.4 Garment Design

The garment design shall comply with the Australian and New Zealand joint standard for garment design, AS/NZS 4602:1999, with the following clauses:

- The design shall include a "shirt-tail" back that is 150mm longer than the front of the garment. The "shirt-tail" may be split, providing an overlap of material ensures that continuity of background material is maintained.
- The minimum amount of background material visible, ie. that material not covered by reflective material or printing, shall be 0.6m².
- The minimum amount of "R" reflective material, in 50mm wide elements, shall be 0.2m².
- The reflective elements shall form a recognised belt and braces pattern with an additional horizontal stripe on the "shirt-tail" which is located no more than 50mm above bottom hem. The braces should join the belt at the front, passing over the shoulder to the belt at the back.
- Each brace shall be spaced a minimum 150mm apart at the belt, front and back.
- Where 'static' electricity is a major safety concern, eg gas related activities, materials to minimise static may be used.

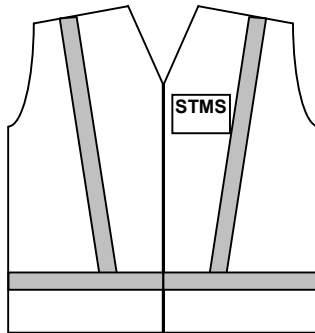
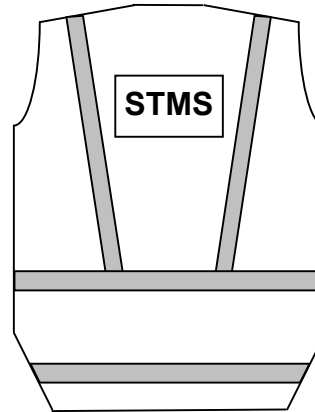
EXPLANATORY NOTE - Site Traffic Management Supervisor (Refer Section B3.6)**Front****Back**

Site Traffic Management Supervisor jackets enable the person responsible for temporary traffic management at a work site to be readily identified by personnel from the RCA, the Engineer or emergency services.

B3.5 Logos

Garments shall not display any lettering, symbols or logos except on a “patch” located on the upper front left side of the garment.

The maximum area of the “patch” shall be 7500mm² (e.g. 100mm x 75mm).

Note: The Site Traffic Management Supervisors (STMS) garment shall not have a “patch”.

B3.6 Site Traffic Management Supervisors (STMS) Garment

The STMS garment is the same as the garment specifications above, except for the following clauses:

- The background fabric colour shall be fluorescent yellow, commonly known as ‘lime yellow’, as specified in Table 2.1 of the AS/NZS 1906.4:1997 standard.
- A reflective fluorescent red orange panel measuring 150mm x 150mm shall be placed on the upper left front of the garment. This panel may cover some of the retro-reflective element at the front.
- A retro reflective fluorescent red orange panel measuring 300mm x 150mm shall be placed on the upper back of the garment, between the retro-reflective braces;
- The legend, **STMS**, shall be displayed on the back and front left panels in the follows manner:

Colour:		Black
Font:		Helvetica Bold
Letter Height:	Front	50mm
	Back	100mm

The garment must not have yellow reflective elements.

An STMS on all **Level 2** and **Level 3** roads must wear this garment.

This garment must also be worn by an STMS on **Level LV** and **Level 1** roads where there are three or more, personnel on site. Where there are less than three personnel on site the STMS may wear a standard garment.

B3.7 Compliance

Manufacturers must be able to demonstrate compliance of fabrics with the AS/NZS 1906.4:1997 standard with a recognised independent testing laboratory's certification of compliance.

The garment label must contain information stating that the garment meets the requirements of this Code of Practice. The letters TTMC can be used as an abbreviation for ‘Temporary Traffic Management Compliant’.

EXPLANATORY NOTE - Long Sleeve Garment (Refer Section B3.8)

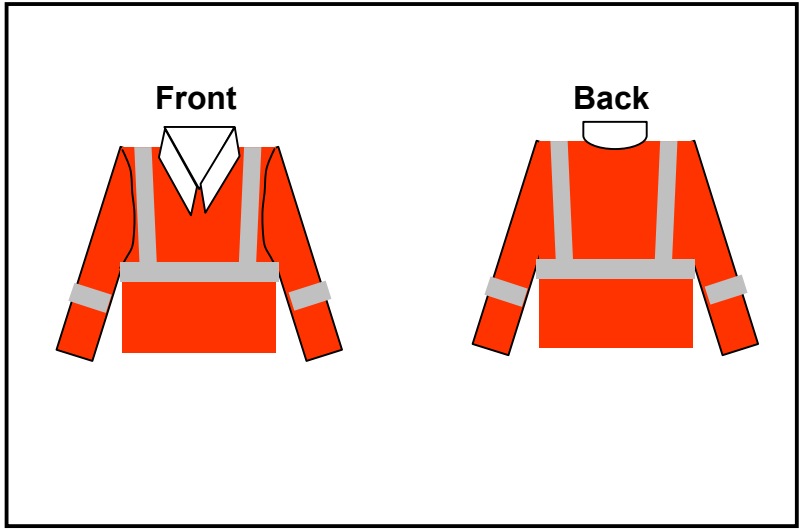

B3.8 Long Sleeve Garment

A worker, supervisor, or visitor may, in some instances, find it necessary to wear a long sleeve garment. If these garments are to act as a 'Hi Visibility Garment' they must comply with the general requirements for Hi Visibility Garments as well as the following additional clauses:

- The 150mm "shirt-tail" can be deleted, because of problems associated with both the manufacture and durability of a long sleeve garment.
- The sleeves of garment should, desirably, be the same fluorescent colour as a standard garment. The minimum amount of background fluorescent material required to be visible, ie. that material not covered by reflective material or printing, is 0.6m², the same as a standard garment.
- A 50mm wide band of complying reflective material shall be located between the wrist and the elbow on each sleeve, to compensate for the loss of the reflective "shirt-tail" stripe.

B3.9 Exemption for Small Garments

Dispensation for an "extra small" fitting garment will be permitted provided it meets the requirements of this code in all respects, except for:

- The minimum area of background fluorescent material is reduced to 0.44 m².
- The minimum area of 50 mm wide reflective material is reduced to 0.16 m².

In addition, the following clauses also apply to "extra small" fitting garments:

- A card, which is clearly viewable to a purchaser, must be included in the garment's packaging stating that this "extra small" fitting garment has reduced visibility in both day and night conditions and that, because of this limitation, those wearing the garment should avoid working in areas of high risk.
- An "extra small" fitting garment is not 'Temporary Traffic Management Compliant' and its label shall not contain the TTMC qualification wording.
- Management must ensure that any employee wearing an "extra small" fitting garment is aware of the potential hazards resulting from its lower visibility.
- A manufacturer may have only one "extra small" fitting garment in their range.

B3.10 Application Date

All High Visibility Garments must comply with the above requirements.

This page is intentionally blank

B4 LOGOS, NAMES AND TRADEMARKS

B4.1 General

Logos, company names and other trademarks must **not** be displayed on the front of traffic signs. The logo, company name or trademarks of the sign's owner may be displayed on the back of signs provided they do not detract from the legibility or reflectivity of the sign.

Traffic management devices, other than signs, and high visibility garments, may have a logo displayed.

Stickers, or the like used, for sign manufacturing purposes must not be reflective and they must be placed on the back of the sign.

B4.2 Area Requirements

Any logo displayed on a traffic sign must not exceed:

- 3,000mm² (e.g. 30mm x 100mm) on signs less than 1m², or on any other traffic management devices.
- 10,000mm² (e.g. 100mm x 100mm) on traffic signs larger than 1m².

No more than one logo shall be displayed on traffic signs, other traffic management devices and high visibility garments.

The requirements for High Visibility Garments is presented in Section B3.

B4.3 Retro-Reflectivity

Logos must not be retro-reflective.

EXPLANATORY NOTE - Portable Traffic Signals (Refer Section B5.1.1)

Portable Traffic Signals must be certified by an independent testing organisation for compliance with AS 4191: 1994 Portable Traffic Signal Systems.

This standard includes operational (Start-Up Sequence), functional (Operator Controls and Visual Monitors), environmental (Temperature and Humidity Tolerances) requirements. It also contains requirements for lanterns, lights, vehicle detectors and power supply.

B5 PORTABLE TRAFFIC SIGNALS

B5.1 Single Lane Signalised Alternating Flow

B5.1.1 General

Portable traffic signals must comply with the Australian Standard AS 4191:1994 - Portable Traffic Signal Systems and must only have two phases. Each phase permits a particular traffic movement and consists of a green period, a yellow period and an all-red period.

Portable signals are usually adequate for traffic control at work sites where their operation is supervised. Where they are required to operate outside working periods a more secure installation will be required, to maintain the integrity of the system.

The requirements for a portable traffic signal installation are normally less stringent than those for a normal signalised intersection. The minimum requirements for a portable traffic signal installation are:

- A power supply source.
- Two signal posts each with a three aspect signal display.
- A vehicle actuated detection system, except where a 'fixed time' or manually operated signal operation is shown to be adequate.
- A system to link each item of hardware.
- A control mechanism.
- An audio alarm system to alert site staff in the event of signal malfunction.

Portable traffic signals must be certified as complying with the Australian Standard for Portable Traffic Signal Systems, AS 4191:1994.

The LTSA Regional Engineer must approve the use of all part-time traffic signal systems before they are installed at a work site.

B5.1.2 Power Supply

The power supply may be either mains or battery but the source and lamp combination must be able to produce the signal lantern light output required by the Austroads Guide to Traffic Engineering Practice, Part 7: Traffic Signals.

B5.1.3 Signal Displays

At most sites a single signal post with a three aspect lantern display is sufficient. However, this is contrary to existing traffic regulations and dispensation from the LTSA Regional Engineer is required. The display should normally be positioned to the left, and adjacent, to a limit line that is located at a point where normal two-way traffic operation restored.

The location of the signal displays in relation to the limit lines and adjacent carriageways should conform to the requirements of the Austroads Traffic Signal guide.

B5.1.4 Detection System

Vehicle detection may be by microwave or infra-red detectors, or by induction loops cut the road surface. The system must be set up to minimise false detections due to adjacent site activity and vehicles on the public road that are leaving the controlled area.

B5.1.5 Linking

The linking between the signal displays on each approach to the controlled area may be provided by a hardwired cable system or by radio transmission.

Co-ordinated time clock systems are not recommended because a temporary failure on one approach will result in the loss of co-ordination and this is unacceptable under alternating flow conditions.

Where cable linking is used, and the cable must cross the trafficked carriageway within the controlled area, the cable should be laid in a saw cut at the crossing point. If saw cutting is not feasible, vehicles should be ramped over the cable using an appropriate ramping system. In general the crossing is best positioned at the midpoint of the controlled area, to minimise the effects of vehicle acceleration, braking and deceleration at the crossing point.

Radio linking must use a suitable frequency and be set up in such a manner that it is unaffected by interruptions to the line of sight between the signal equipment at each end of the controlled area.

In special circumstances linking cables may be suspended from securely anchored centenary wires. The cable must be at least one metre above the maximum legal vehicle height. Six metres is normally an adequate minimum clearance.

B5.1.6 Controller

The signal controller must provide a two-phase operation with each phase having the following features:

- a fixed minimum green period,
- a variable or fixed maximum green period,
- a variable or fixed gap timer,
- a fixed yellow time, which must not be less than three seconds, and
- a variable all-red time.

The preferred method of operation for a vehicle actuated system is that, in the absence of a vehicle demand, it should “rest-in-green” in on the last approach serviced.

Some portable controllers can generate a dummy opposing demand after a preset time, eg. three minutes, to ensure a non-detected vehicle is never trapped on either approach.

B5.1.7 Maintenance and Emergencies

A maintenance contract to ensure immediate priority attention to a fault in an alternating flow traffic signal system must be arranged prior to the installation of the system.

A person experienced in the operation of traffic signals should undertake the design and installation of the control and detection equipment.

During daylight and site work hours, the contractor should have access to a back-up system that can take over from the traffic signal operation in the event of unusual congestion or failure of the control system. The signal displays must be removed or securely covered before such a backup system is implemented.

B5.1.8 Types of Operation

The three modes of portable traffic signal operation are:

- Vehicle-actuated.
- Fixed time.
- Manual.

B5.1.8.1 Vehicle-Actuated Operation

Vehicle-actuated is the preferred operating mode and must be used wherever possible.

Vehicle-actuated operation allows the signals to automatically respond to vehicle demands. Phase lengths are adjusted automatically to suit the traffic flows and this ensures that traffic queues and delays are kept to a minimum.

For alternating flow under vehicle-actuated operation the signals must change automatically when either:

- there is a steady stream of vehicles and the maximum green timer has expired, or
- the gap between successive vehicles is greater than a predetermined interval, and the minimum green timer has expired..

If the phase changes at the maximum green time, a new demand must be automatically generated for that phase. This ensures that any vehicles stopped by the signal change and undetected will be serviced, without the need for the system to detect the arrival of another vehicle on that approach.

B5.1.8.2 Fixed-time Operation

Fixed-time operation is an automatic mode that cannot respond to varying vehicle demands. The traffic signal cycles according to predetermined timings and this is likely to result in vehicles being delayed for no apparent reason when the road is clear.

Fixed-time control must, therefore, only be used under the following conditions:

- a vehicle detector fails, and
- no manual signal operator available.

B5.1.8.3 Manual Operation

Manually operated portable traffic signals are useful:

- when a detector fails in a vehicle-actuated system, and
- for the management of plant crossing the road at irregular intervals.

B5.1.9 Timing of Signal Displays

B5.1.9.1 Fixed Minimum Green

A fixed minimum green period of six seconds is normally sufficient to ensure that the traffic flow can start up and that detection of successive vehicles will activate the gap timer in the appropriate manner, which will extend the green period, up to the maximum green time set if necessary.

B5.1.9.2 Gap

This timer is activated by the detection system and times the gap between successive vehicles on the approach to the signal, when the signal is showing a green display. Its normal value is in the range two to six seconds but it is site specific and very much dependent on traffic speed.

Traffic flows when the signal is showing a green display should be observed at various times of the day. If the phase seems to regularly terminate before the maximum green time expires, and the distances between successive vehicles in the traffic flow are not excessive the gap time should be increased, in one-half second increments.

Conversely, if the phase seems to regularly terminate at the maximum green time or the distances between successive vehicles in the traffic flow seem excessive the gap time should be decreased. Minor adjustment to the gap time can have a major effect on the efficiency of a vehicle actuated traffic signal operation.

B5.1.9.3 Maximum Green

For a vehicle actuated traffic signal operation the maximum green timing starts as soon as the green signal is displayed if there is already a vehicle call for the other phase, or immediately a vehicle call for the other phase is received during the current phase, whichever is the sooner.

The green signal will continue to be shown provided there is constant stream of traffic and vehicle spacings are less than the gap time setting. The phase will terminate when the maximum green timer expires.

When a fixed time traffic signal operation is employed, the green time for each phase will always be the maximum value set, irrespective of traffic demands. Maximum green time settings should, therefore, be changed for the peak hours, off peak times, weekends and nights, to avoid excessive delays. Changes may be made manually or by ‘time of day’ commands, depending on the type of signal controller being used. Fixed time traffic signal operation is **NOT** recommended for temporary traffic management.

The following method may be used for setting maximum green times at short duration work sites where flows do not exceed 800 vph and are roughly equal in each direction.

Procedure

1. Measure the site length and set the maximum green time to the value shown the table below:

Site Length (metres)	Maximum Green Time Setting (seconds)
30 – 74	35
75 – 134	40
135 – 194	45
195 – 300	50

Table B5.1: Maximum Green Settings

(Procedure continues on next page)

2. Observe the traffic queues at various times of the day. If the last vehicle in queue regularly takes more than one green period to reach the limit line, increase that approaches maximum green time setting by five seconds.

Where the traffic flows exceed 800 vph a more precise calculation will be required to determine the appropriate maximum green time setting. A person familiar with traffic signal analysis must be employed to carry out this work.

B5.1.9.4 Fixed Yellow

The fixed yellow time for alternating flow traffic signal sites is four seconds.

EXPLANATORY NOTE - Start-up Sequence (Refer Section B5.1.10)

Portable traffic signals that comply with the Australian Standard AS4191-1994 will automatically start-up with the sequence outlined in B5.1.10: Start-up Sequence.

B5.1.9.5 All-Red

The length of the all-red period is a function of the length of the site, site conditions and the average speed of vehicles through the site. A very long all-red setting can result in long delays that cause road user frustration, which in turn can lead to a red signal being disregarded. A very short all-red signal, particularly where visibility is restricted, can be equally dangerous.

The all-red time must be at least five seconds. The all-red times recommended for straight level sites are given in the table below:

Straight Level Site Length (metres)	Recommended All Red Time (seconds)
Less than 50	5
50 – 99	10
100 – 149	15
150 – 199	20
200 – 249	25
250 – 300	30

Table B5.2: Recommended All Red Times

Note: Site length is the distance between the traffic signal limit lines at each end of the site.

The all-red time may need to be adjusted where gradient, road surface condition, or a high proportion of heavy vehicles affect travel times through the site. As work progresses the all-red times should be reviewed on a regular basis, to ensure they are neither too long nor too short.

B5.1.9.6 Inter-Green

The inter-green time is the period between successive green phases when all signals display a red aspect. The inter-green time is the sum of the yellow time and the red-time for that phase and allows vehicles to safely clear the controlled area.

B5.1.10 Start-up Sequence

Portable traffic signals must start-up with the following sequence:

- display a flashing yellow signal on all approaches for at least 10 seconds, and then
- display a continuous yellow signal to all approaches for the pre-set yellow time, and then
- display a red signal on all approaches for at least 10 seconds, and then
- display a green signal for the first approach in the phasing sequence.

EXPLANATORY NOTE - Flashing Yellow (Refer Section B5.1.11)

The Traffic Regulations 1976 and the New Zealand Road Code include driving rules for the flashing yellow traffic signal display. When a traffic signal shows a flashing yellow display the New Zealand Give Way rules apply.

Note: Flashing yellow will be displayed for a short period of time when traffic signals are starting up.

Portable traffic signals that comply with the Australian Standard AS4191-1994 automatically display flashing yellows in accordance with B5.1.11: Flashing Yellow Mode.

B5.1.11 Flashing Yellow Mode

In flashing yellow mode, the red and green signals remain blank and the yellow aspects on all approaches flash at a rate of approximately 60 flashes per minute.

Portable traffic signals must operate in a flashing yellow mode:

- during the start-up sequence, and
- automatically within a half a second of any of the following hazardous conditions occurring:
 - A green signal is shown simultaneously on both approaches of an alternating flow operation.
 - A green or yellow signal shown to one approach and red on the other approach of a haul route crossing control operation.
 - If one approach shows a green signal and the other approach shows yellow signal.
 - When any lamp fails.
 - Under fixed-time or vehicle-actuated operation a lamp fails to extinguish.
 - Under manual operation a green or yellow signal does not remain illuminated for the minimum green or yellow time.
 - If more than one aspect is illuminated on a signal display.
 - If the communication link between components in a system is disrupted for a continuous period of five seconds. This applies to any breakdown in data transmission.
 - If a radio linked system receives conflicting commands or status data from another signal installation within radio range.

B5.2 Haul Route Crossing

B5.2.1 Traffic Signal Design

The general layout and installation of this type of traffic signal is similar to that of a normal signalised intersection. The design should, therefore, comply with the requirements of the Austroads Guide to Traffic Engineering Practice - Part 7: Traffic Signals.

A primary and secondary signal display is generally sufficient for the haul road approaches and tertiary displays may normally be omitted.

Notes detailing covering the method of signal operation shall be shown on the intersection design drawings,

B5.2.2 Modes of Operation

B5.2.2.1 Vehicle Actuation

Vehicle actuation is the preferred mode of operation and vehicle detection should be provided on all approaches. A permanent recall is to be provided for the public road approaches, to ensure the signals return to green on that road on the termination of the haul route phase and in the event of a detector failure on the public road.

If a detector ceases to function on the haul road route that phase may be manually controlled until the detector is repaired.

B1.1.1.1 Fixed Time Operation

This mode of operation shall not be used for the public road phase at haul road crossings. It may, however, be used for the haul route phase.

B5.2.2.2 Manual Control

Local site conditions or the nature of the haul road traffic may preclude the use of normal vehicle detectors and microwave detectors should not be used where work site operations in the vicinity of the crossing may generate spurious demands. Also, very slow moving vehicles may not activate microwave detectors. Under these conditions and where, in the opinion of the RCA, vehicle actuation is not practicable, manual control may be used.

For manual control it is essential that the operator can clearly observe traffic conditions on all approaches and that they ensure delays to the traffic on the public road are minimised. The signals should also rest in green for the public road phase when there is no demand for the road phase.

B5.2.2.3 Partial Manual Control

Partial manual control is preferred to full manual control. Under this system the public road approaches are controlled by a detection system and demands for the haul route approaches are made manually. The haul road phase is also extended by a manual operation, up to the maximum green time set for that phase

B5.3 Signal Controlled Site Access

Vehicles leaving a site through a red signal at a traffic signal controlled intersection will be deemed to be entering the public road illegally. Where vehicles may be required to leave such a site, and the intersection operates under manual or partial manual control, and there are no manual controllers on site, an alternative exit point must be provided. This point must be located well away from the controlled intersection.

B5.4 Application Date

Portable traffic signals must comply (as of 1 July 2003) with the above requirements for *all Levels* of traffic management.

EXPLANATORY NOTE - Use of Plastic Water Filled Devices as a Safety Fence

Plastic water filled fences and barriers that do not comply with the requirements of TNZ M/23: 2002, must not be used as barriers. (Refer B11 for details of barrier systems).

However, plastic water filled fences and barriers may be used as a safety fence under the following conditions:

- The design and installation must comply with the requirements of Clause B6.2;
- Must be separated from any live lane by a minimum of a 1.0 m lateral safety zone and a row of cones at the appropriate spacings.

B6 SAFETY FENCES

B6.1 General

Safety fences are required to prevent people from gaining access into a hazardous area. This is particularly important at unattended work sites.

B6.2 Design

Safety fences shall:

- have a secure supportive top and bottom rail,
- have the top rail located a minimum of 1.0m above ground level,
- have the bottom rail located a maximum of 100mm above ground level,
- be continuous around the hazard,
- be clipped or joined together, if in sections, to form a continuous fence surrounding the hazard,
- have top and bottom rails that terminate with a vertical rail,
- have a mesh in-fill or solid panels that are difficult to climb and are fluorescent orange or alternating white and fluorescent orange in colour,
- remain upright and stable under all expected site conditions, and
- be free of sharp objects.

B6.3 Night Use

Yellow flashing warning lamps must be placed on safety fences and barricades when they are used to protect a hazard less than 30 metres long on **Level 1** roads. A lamp must be placed on at least each corner of the safety fence to help make the hazard more identifiable.

On *all Levels* of road the delineation of hazards parallel to the direction of traffic and more than 30 metres long shall be by safety fences or barricades fitted with suitable reflectorised delineators. This Code of Practice recommends the use of the 200mm x 150mm Retro-Reflective Chevron delineators shown in Figure B11.1. These should be installed at ten metre spacing and at every change of direction of the safety fence or barricade.

B6.4 Application Date

All safety fences and barricades must comply with the above requirements for *all Levels* of traffic management.

This page is intentionally blank

B7 BARRICADES

B7.1 General

Barricades shall only be used for delineation of a hazard behind a line of delineation devices. Barricades may also be used to physically close roads.

Barricades shall be lightweight, frangible and constructed from non-splintering plastic material. When in place on site the barricade, consisting of legs and a sight rail, must be joined together to form a one-piece unit.

Hurdles are **NOT** a recommended temporary traffic management device and this Code of Practice discourages their use. Cones or barricades can usually be used instead of hurdles.

B7.2 Dimensions

Barricades shall:

- have sight boards with a vertical dimension of 150mm to 300mm and horizontal lengths of 600mm to 1800mm, and
- the sight board shall be mounted with the centre line of the uppermost rail 900mm, \pm a 120mm tolerance, above the ground surface.

B7.3 Colour

Barricades must be:

- a fluorescent orange colour that conforms to the CIE chromaticity co-ordinates in Table 2.1 of the joint Australian and New Zealand Standard AS/NZS 1906.4:1997, and
- conform to the minimum luminance factors specified with Table 2.2 of the joint Australian and New Zealand Standard AS/NZS 1906.4:1997.

Barricade sight boards must have alternating 100mm wide white and fluorescent orange stripes that slope at 45 degrees to the vertical, with the lowest point of the stripes towards the live lane. The stripes shall be at least Class 1 retro-reflective material and shall be applied to the full length of the sight board.

B7.4 Application Date

The barricade requirements detailed above are effective from 1 July 2000, for *all Levels* of traffic management except for the requirement for barricades to be constructed from plastic and to form a one-piece unit, which is effective from 1 July 2005.

This page is intentionally blank

B8 ARROW BOARDS

B8.1 General

Arrow boards shall be legible at distances greater than 800 metres. They must at least comply with the requirements of the joint Australian/New Zealand standard AS/NZS 4192 and, preferably, with the Millennium Edition of the American Federal Highway Administration’s Manual on Uniform Traffic Control Devices Section 6F-53: Arrow Panels and Figure 6F-3: Advance Warning Display Specifications.

B8.2 Design

Arrow boards must have the following features:

Lamp Colour	Amber
Lamp Diameter	At least 80 mm
Flash Rate	25 to 40 flashes per minute
Number of Lamps	At least 25 and a minimum of five 5 per chevron
Lamp Dimming	Adjustable intensity with automatic and manual switching to not more than 50% of rated voltage

Table B8.1: Arrow Board Design Requirements

Pilot lights, or other controls, located in the vehicle shall be used to confirm the operation and mode of an arrow board.

B8.3 Size

Arrow boards must be:

- at least 1200mm wide by 600mm high for use on **Level 1** and **Level 2** roads, and
- at least 1500mm wide by 700mm high for use on **Level 3** roads.

B8.4 Display Configurations

The position on the carriageway of the vehicle carrying the arrow board determines which of the two arrow board displays approved for temporary traffic management use on New Zealand roads is to be shown. Details of these display modes are given in the following table:

Mode	Display	Situation
<p>Single Sequential Arrow (with tail)</p>	<p>Arrowhead moving left or right depending on the direction drivers are being directed to follow, refer to Figure C17.1 for more details.</p>	<p>The arrow board vehicle is in a live lane but a minimum lane width is available for traffic to safely pass on one side of the vehicle.</p>
<p>Caution Mode</p>	<p>All four corner lights flash simultaneously, refer to Figure C17.2 for more details.</p>	<ul style="list-style-type: none"> • The arrow board vehicle is in a live lane but a minimum lane width cannot be provided on either side of the vehicle. • The arrow board vehicle is on a shoulder and the carriageway is entirely unaffected.

Table B8.2: Permissible Display Configurations

- Notes:**
1. The operational requirements listed above vary from those shown in AS/NZS 4192.
 2. Arrow boards shall not show a left and a right arrow at the same time.

B8.5 Location

Arrow boards for static operations must be positioned in the centre of the closed lane taper and behind the taper delineation devices.

When an arrow board is operating all other vehicles with rotating flashing beacons in the working area shall be positioned such that the visual performance of the arrow board is not impaired.

B8.6 Application Date

All arrow boards must comply with the above requirements for *all Levels* of road.

This page is intentionally blank

EXPLANATORY NOTE - Variable Message Signs (Refer Section B9.1)

Regulation 129(1) of the Traffic Regulations 1976 states:

“Every traffic sign shall comply with the appropriate description given in the Fourth Schedule to these regulations,

The Fourth Schedule includes detailed descriptions of the signs shown in the Transit New Zealand / LTSA Manual of Traffic Signs and Markings.

The 1976 Traffic Regulations do not specifically cover variable message signs. They must, however, be considered signs and, therefore, regulation 129(1) applies. Variable message signs that do not comply with the Fourth Schedule require either the approval of the Regional Manager of the LTSA or the RCA, before installation.

Transit New Zealand is currently working with the LTSA to develop policies for variable message signs used for temporary traffic management systems in Auckland and Wellington. The resulting policies will also allow, and provide guidance for, the use and design of variable message signs for temporary traffic management in other areas.

B9.4 Operation

- Variable message signs should be composed of a matrix of light sources either; orange, yellow, white, fluorescent orange or lime green; or of 'glow cube' type 'pixels', preferably with rounded corners. Light source matrices should have more than one light per pixel, ie. double lines of lights should represent vertical and horizontal strokes of letters. Red light sources may only be used with specific approval from the LTSA and the RCA.
- Non-light-matrix types of sign must be illuminated for night use.
- Signs requiring a power supply to operate or for illumination should have a backup power supply, eg. a battery, to cater for failure of the primary power supply and, preferably, an alarm system if the back up supply is not adequate for eight hour's continuous operation.
- Light output dimming should be provided for night time operation.
- The sign should have a cowl to prevent sunlight reducing the effectiveness of the sign by 'washing out' the message and to reduce specular reflection off the face of the sign panel.

B9.5 Mounting of Sign

Variable message signs shall be located in a similar position to an equivalent conventional temporary traffic sign. Signs should be mounted on a frangible post, pole or other support structure and be located behind an approved delineation device.

If a variable message sign is mounted on a non-frangible post, pole or other support structure it shall be protected by an approved barrier system or a non-gating re-directive crash attenuator.

B9.6 Application Date

All variable message signs must comply with the above requirements for *all Levels* of road.

This page is intentionally blank

EXPLANATORY NOTE - Truck Mounted Attenuators (TMA) (Refer Section B10.1)

A TMA generally consists of an energy absorption cartridge, a rigid backup, a steel support structure and an under-ride that attaches the crash cushion to the truck. TMAs have the same basic energy absorbing principles as the stationary crash cushions that are used to protect permanent roadside hazards. Their purpose is to evenly and gradually dissipate the kinetic energy of an impacting vehicle. TMA also prevent an impacting vehicle from under riding the truck body, which can result in shearing the top off the impacting vehicle at the bonnet line.

EXPLANATORY NOTE - NCHRP 230 and 350 (Refer Section B10.1)

National Co-operative Highway Research Program (NCHRP) Report 230 was published in 1981 and before TMAs were in wide spread use. The report does not, therefore, include specific tests for TMA. Tests 50 to 54 were developed for testing devices such as clusters of drums used to shield bridge piers etc. The tests involve various vehicles from 1800 lbs. to 4500 lbs. impacting the device at 60 mph from a number of different angles.

NCHRP Report 350 was published in 1993 and it includes specific tests for TMA. The tests involve impacting light vehicles and utility trucks into the device at various speeds.

EXPLANATORY NOTE - NCHRP 350 Test Level 3 (TL3) TMAs

It is Transit New Zealand's vision that as from 1 January 2008 all TMAs used on roads with permanent posted speed limits greater than 70 km/h shall comply with the requirements of NCHRP Report 350 Test Level 3 (TL-3).

B10 TRUCK MOUNTED ATTENUATORS (TMA)

B10.1 Design

TMA's must be certified for compliance with NCHRP Report 350 Tests 50 and 51.

Test Level 2 is the basic test level for TMA's and they must meet this performance requirement.

With positive temporary traffic management, Test Level 2 has been shown to be effective for crashes at speeds greater than 70 km/h.

Note that the compliance rating for TMA's shall be displayed on both sides of the unit and at the truck-mounting end of the unit, in black 100mm high lettering and reading as NCHRP 350: TL-2.

B10.2 Vehicles

All vehicles equipped with a TMA must:

- meet all vehicle requirements recommended by the manufacturer of the TMA;
- be legally permitted to travel on the road. Special approval may, however, need to be obtained from the LTSA for some TMA's, eg. an over width or over length permit and
- have seat belts, conforming to LTSA requirements, fitted and the seat belts must be worn by all personnel in a TMA vehicle.

B10.3 Application Date

TMA's are to be used on *all Levels* of roads, where required. Refer to Section C18 for static work sites and Section D5 for mobile operations.

All TMA's must comply with the requirements of NCHRP 350 Test Level 2 when used on roads with a permanent posted speed limit greater than 70 km/h.

TMA seatbelts must be fitted by 1 July 2005.

EXPLANATORY NOTE - Standards for Barrier Systems (Refer Section B11.1)

Transit New Zealand updated their TNZ M/23 specification for Road Safety Barrier Systems in 2002. This specification sets out the requirements for the supply and installation of permanent barrier systems for roads and bridges. The specification does not apply to the temporary or portable longitudinal barriers used at work sites.

The joint Australian and New Zealand for Road Safety Barrier Systems is AS/NZS 3845: 1999. This standard uses the testing requirements of NCHRP 350 and it does apply to the temporary and portable barrier systems used at work sites. If in doubt refer to AS/NZS 3845: 1999 for clarification.

B11 BARRIER SYSTEMS

B11.1 General

Barrier systems used for temporary traffic management include rigid, semi-rigid and flexible systems constructed of plastic, steel, concrete and other materials. Section C19 of this code, Barrier Systems, includes guidelines and requirements for the use of barrier systems and end treatments.

B11.2 Design

Barrier systems must meet acceptable performance standards when tested in accordance with evaluation procedures recommended by the National Cooperative Highway Research Program (NCHRP) Report 350.

A road safety barrier system is considered to be NCHRP Report 350 compliant to a specified test level by being:

- listed on the FHWA website at:
<http://safety.fhwa.dot.gov/fourthlevel/hardware/longbarriers.htm>; or
- listed in AS/NZS 3845:1999; or
- deemed to comply by the Road Controlling Authority. For State Highways, Transit's Highway Strategy and Standards Manager may deem a system to comply based on test results from an independent testing organisation that show it complies with a specific NCHRP Report 350 test regime.

Barrier systems used at worksites must comply to minimum performance levels listed below:

- A Test Level 1 (TL-1) barrier must be used where the permanent or temporary speed limit is 50 km/h or less.
- A Test Level 2 (TL-2) barrier must be used where the permanent or temporary speed limit is more than 50 km/h but not higher than 70 km/h.
- A Test Level 3 (TL-3) barrier must be used where the permanent or temporary speed limit is higher than 70 km/h.

All barriers shall have a smooth surface finish, to reduce the possibility of a vehicle snagging on impact. A smooth surface finish also reduces the risk of fire and promotes the vehicle to sliding along the barrier, which ensures that ride down acceleration is kept as low as practical.

B11.3 Colour

Barrier systems that also serve as traffic channelling devices shall be constructed with conspicuously coloured alternating sections. Conspicuous colours include orange, white and red.

Section C19: Barrier Systems, requires barrier systems that serve as traffic channelling devices to be visible at night. Light grey concrete and galvanised steel barriers are acceptable in these situations provided the face of the barrier is clean.

B11.4 End Treatments

All Barrier systems shall be fitted with end terminal treatments that are specifically designed for that purpose.

EXPLANATORY NOTE - Recommended Delineation for Barrier Systems (Refer Section B11.5)

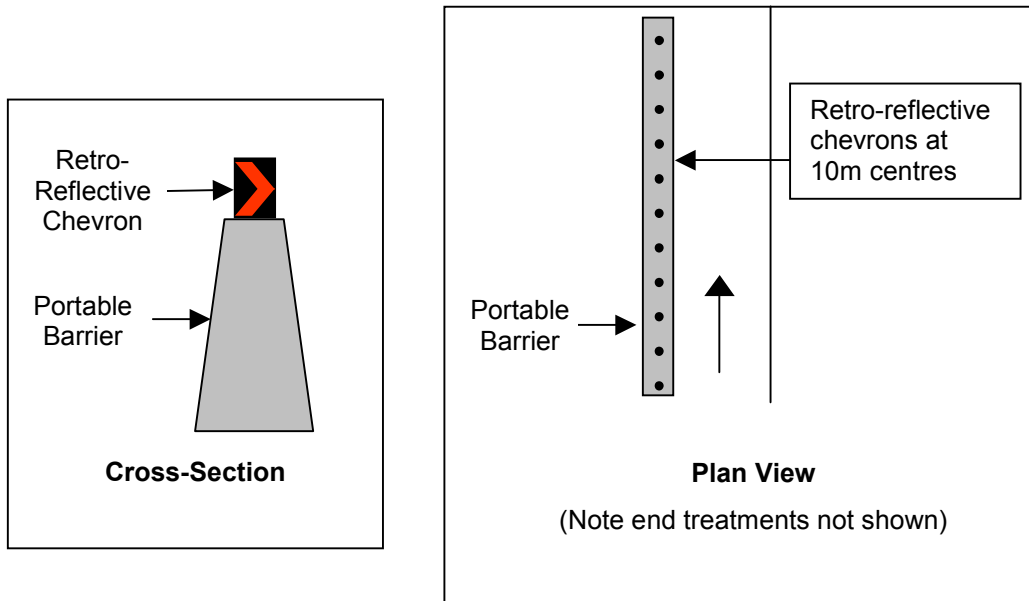

B11.5 Channelling Traffic

Barrier systems that are also used to channel traffic shall be fitted with reflective markers along the top of the barrier as shown in Figure B11.1.

The chevron shall consist of a fluorescent orange arrowhead on a rectangular black background 150mm x 200mm. The chevron shall point to the side of the barrier that traffic is to pass. Chevrons shall be placed at 10m centres along the barrier.

Barrier systems should not be the primary type of delineation for tapers, except on roads with permanent speed limits of 65 km/h or less.

Where barrier systems are used on roads with permanent speed limits higher than 65 km/hr the primary means of delineation shall be road marking and a row of cones must be placed outside the barrier. When the barrier is removed the temporary markings shall be removed by water blasting, or another removal technique approved by the Engineer.

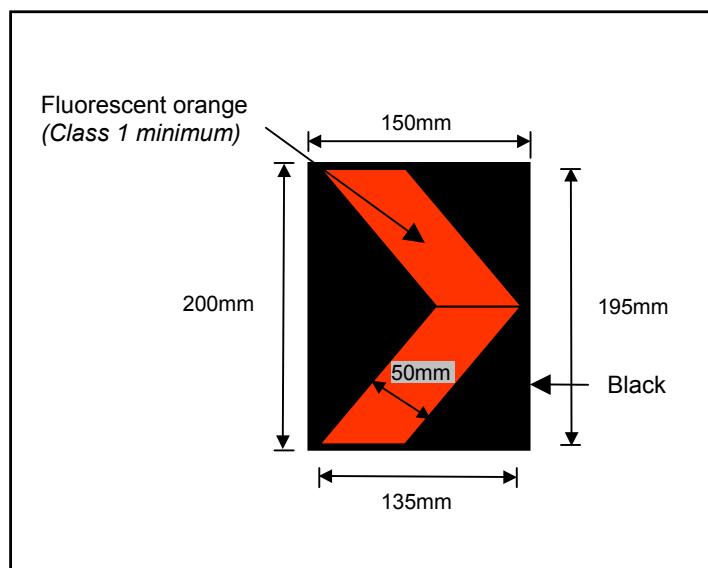

Figure B11.1: Retro-Reflective Chevrons

B11.6 Application Date

All barrier systems and end treatments must comply with the above requirements for *all Levels* of roads.

This page is intentionally blank